



## 2020 CHEVY/GM 2500 4WD 5"- 7" NTD LIFT KIT

**Thank you for choosing Rough Country for all of your suspension needs.**

Rough Country recommends a certified technician installs this system. In addition to these instructions, professional knowledge of disassemble/reassembly procedures as well as post installation checks must be known. Attempts to install this system without this knowledge and expertise may jeopardize the integrity and/or operating safety of the vehicle.

Please read all the instructions before beginning the installation. Check the kit hardware against the Kit Contents list on next page. Be sure you have all the needed parts and understand where they go. Also please review the tools needed list to be certain that you have the tools necessary to complete the installation.

### **PRODUCT USE INFORMATION**

**⚠ WARNING** As a general rule, the taller a vehicle is the easier it will roll. We strongly recommend, because of rollover possibility, that seat belts and shoulder harnesses should be worn at all times. Avoid situations where a side rollover may occur. Braking performance and capabilities are decreased when significantly larger/heavier tires and wheels are used. Take this into consideration while driving. Also, speedometer recalibration is necessary when larger tires are installed.

Do not add, alter, or fabricate any factory or after-market parts which increase vehicle height over the intended height of the Rough Country product purchased. Mixing component brands, lifts, with this suspension lifts voids all warranties. Rough Country makes no claims regarding lifting devices and excludes any and all implied claims. We will not be responsible for any product that is altered.

Due to differences in manufacturing, dimension and inflated measurements, tire and wheel combinations should be test fit prior to installation. For 7" & 5" applications we recommend a wheel not to exceed 9" in width with 5" of backspacing.. Additionally a quality tire of radial design is recommended, not exceeding 37" tall and 12.5" wide for 7" lift and 35" tall and 12.5" wide for 5" lifts. Please note that modification to the front valance may be required. Factory wheels will not be able to be used.

**⚠ NOTICE** Gas models may require modification to the exhaust for front driveshaft clearance. We recommend an exhaust professional perform this modification.

### **⚠ NOTICE NOTICE TO DEALER AND VEHICLE OWNER**

Any vehicle equipped with any Rough country product must have the "Warning to Driver" decal installed on the sun visor or dash. The decal is to act as a constant reminder for whoever is operating the vehicle of its unique handling characteristics. **INSTALLING DEALER**—It is your responsibility to install the warning decal and to forward these installation instructions on too the vehicle owner for review and to be kept in the vehicle for its service life.

***We hope installing your Rough Country lift kit is a positive experience. Please note that variations in construction and assembly in the vehicle manufacturing process will virtually ensure that some parts may seem difficult to install. Additionally, the current trend in manufacturing of vehicles results in a frame that is highly flexible and may shift slightly on disassembly prior to installation. The use of pry bars and tapered punches for alignment is considered normal and usually does not indicate a faulty product. However, if you are uncertain about some aspect of the installation process, please feel free to call our tech support department at 800-222-7023. We do not recommend that you modify the Rough Country parts in any way as this will void any warranty expressed or implied.***



**5" Kit**



**TOOLS NEEDED:**

10mm socket /wrench  
 11mm socket /wrench  
 13mm Deep Socket  
 13mm wrench  
 15mm socket / wrench  
 17mm socket / wrench  
 18mm socket /wrench  
 19mm socket /wrench  
 21mm socket /wrench  
 24mm socket /wrench

1/2" Socket/Wrench  
 9/16 socket /Wrench  
 Torsion bar Tool  
 Drill  
 13/32 Drill Bit  
 Loc-Tite  
 Reciprocating Saw  
 Floor Jack  
 Jack Stands  
 Torque Wrench

**7" Kit**



**Torque Specs:**

Size	Grade 5	Grade 8	Size	Class 8.8	Class 10.9
5/16"	15 ft/lbs	20ft/lbs	6MM	5ft/lbs	9ft/lbs
3/8"	30 ft/lbs	35ft/lbs	8MM	18ft/lbs	23ft/lbs
7/16"	45 ft/lbs	60ft/lbs	10MM	32ft/lbs	45ft/lbs
1/2"	65 ft/lbs	90ft/lbs	12MM	55ft/lbs	75ft/lbs
9/16"	95 ft/lbs	130ft/lbs	14MM	85ft/lbs	120ft/lbs
5/8"	135ft/lbs	175ft/lbs	16MM	130ft/lbs	165ft/lbs
3/4"	185ft/lbs	280ft/lbs	18MM	170ft/lbs	240ft/lbs



**10230 5" Kit**

10130BOX1  
10130BOX2  
10130BOX3  
10230BOX1  
10230BOX2  
1253BOX6  
23152 X2  
23153 X2

**10130BOX1**

Driver Side Knuckle x1

**10130BOX2**

Passengers Side Knuckle x1

**10130BOX3**

Front Crossmember x1

Rear Crossmember x1

**10230BOX1**

10230INSTBAG 5-7" Instructions x1

10130BAG1

10130BAG2

10130BAG8

10130BAG4

10130BAG5

1959BAG9

1253BAG2

5/8BAG

1253BAG9 x2

Rear Bump Stops x2

Driver Diff Bracket x1

Pass Diff Bracket x1

Sway Bar Bracket x2

Front Sway Links x2

NTD Sleeves x2

**10230BOX2**

Rear Lift Block x2

5/8" x 3" x 16" U-Bolts x4

Driver 5" NTD Bracket x1

Pass 5" NTD Bracket x1

**1253BOX6**

Diff Skid Plate x1

**1253BAG9: Knuckle Bag x2**

**Cable Clamp x1**

**1253BAG2: For Crossmembers**

**18MM-2.5 X 120MM Hex Head Bolt x2**

**18MM-2.5 X 140MM Hex Head Bolt x2**

**18MM-2.5 Nylock Nut x4**

**3/4" Flat Washers x8**

**10130BAG1: For Diff and Skid Plate**

**12mm-1.75 x 35mm Hex Head Bolt x5**

**12mm-1.75 Flange Locknut x5**

**7/16" Flat Washers x5**

**3/8" Lock Washers x2**

**3/8" Nuts x2**

**3/8" Flat Washers USS x2**

**3/8-16" Flange Locknut x2**

**3/8-16 x 1-1/4 Hex Head Bolt x6**

**3/8" Flat Washers SAE x8**

**10130BAG2: NTD Bracket Hardware**

**3/4-10 x 6 Hex Head Bolt x2**

**3/4" Flat Washer x4**

**3/4-10 Lock Nut x2**

**9/16-12 x 3.5 Hex Head Bolt x2**

**9/16-12 Lock Nut x2**

**9/16" Flat Washers x4**

**10130BAG4: Front / Rear Brake Line Bracket Hardware**

**5/16-18 x 3/4 Hex Head Bolt x8**

**5/16" Flat Washer x8**

**5/16-18 Flange Lock Nut x8**

**3/8-16 x 1-1/4 Hex Head Bolt x4**

**3/8" Flat Washers x4**

**3/8" Bump Stop Flag Nut x4**

**10130BAG5: Brake Line Brackets**

**Rear Axle Brake Line Brackets x5**

**Front Brake Line Brackets x2**

**Brake Line Bracket x2**

**Diff Brake Line Bracket x2**

**Front Skid Plate Brackets x2**

**Rr Bump Stop Flag Nuts x4**

**10130BAG8: For Sway Bar Relocation**

**3/8" Lock Washer x4**

**3/8-16 x 1-1/2 Hex Head Bolt x4**

**3/8-16 Hex Nut x4**

**5/16" Flat Washer x4**

**5/8BAG: For U-Bolts**

**5/8-18 Nylock Nuts x8**

**5/8" Flat Washers x8**

**1959BAG9: Torsion Key Retainer Bag**

**Torsion Key Bolt Retainer x2**



**10130 7" Kit**

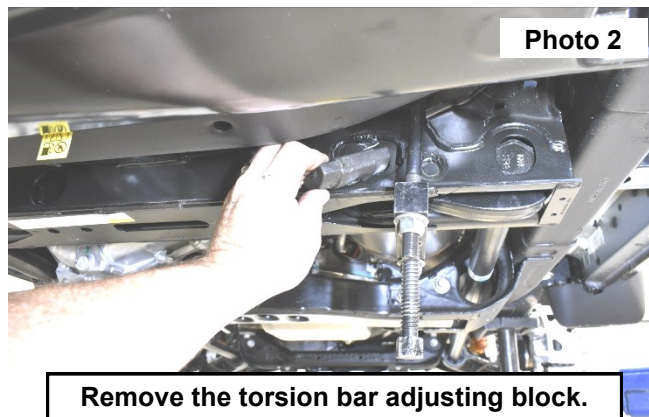
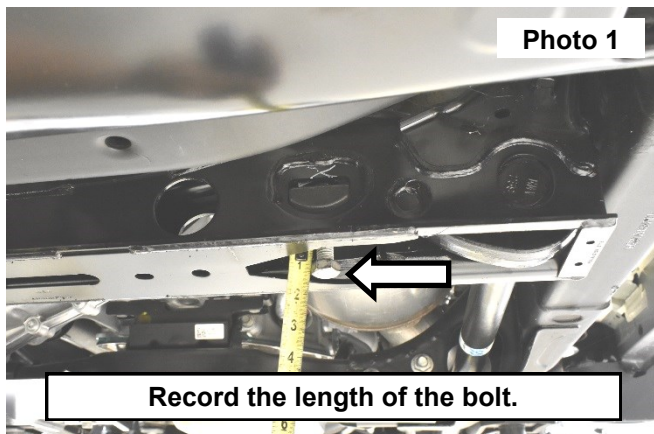
- 10130BOX1
- 10130BOX2
- 10130BOX3
- 10230BOX1
- 10130BOX7
- 1253BOX6
  
- 10130BOX1
  - 1253BAG9 x1
  - Driver Side Knuckle x1
- 10130BOX2
  - 1253BAG9 x1
  - Passengers Side Knuckle x1
- 10130BOX3
  - Front Crossmember x1
  - Rear Crossmember x1
- 10230BOX1
  - 10230INSTBAG 5-7" Instructions x1
  - 10130BAG1
  - 10130BAG2
  - 10130BAG8
  - 10130BAG4
  - 10130BAG5
  - 1959BAG9
  - 1253BAG2
  - 5/8BAG
  - 1253BAG9 x2
  - Rear Bump Stops x2
  - Driver Diff Bracket x1
  - Pass Diff Bracket x1
  - Sway Bar Bracket x2
  - Front Sway Links x2
  - NTD Sleeves x2
- 10130BOX7
  - 1592BAG4
  - Rear Lift Block x2
  - 5/8" x 3" x 17" U-Bolts x4
  - Driver 7" NTD Bracket x1
  - Pass 7" NTD Bracket x1
  - CV Spacer x1
- 1253BOX6
  - Diff Skid Plate x1

- 1253BAG9: *Knuckle Bag* x3
- Cable Clamp x1
- 1253BAG2: *For Crossmembers*
  - 18MM-2.5 X 120MM Hex Head Bolt x2
  - 18MM-2.5 X 140MM Hex Head Bolt x2
  - 18MM-2.5 Nylock Nut x4
  - 3/4" Flat Washers x8
- 10130BAG1: *For Diff and Skid Plate*
  - 12mm-1.75 x 35mm Hex Head Bolt x5
  - 12mm-1.75 Flange Locknut x5
  - 7/16" Flat Washers x5
  - 3/8" Lock Washers x2
  - 3/8" Nuts x2
  - 3/8" Flat Washers USS x2
  - 3/8-16" Flange Locknut x2
  - 3/8-16 x 1-1/4 Hex Head Bolt x6
  - 3/8" Flat Washers SAE x8
- 10130BAG2: *NTD Bracket Hardware*
  - 3/4-10 x 6 Hex Head Bolt x2
  - 3/4" Flat Washer x4
  - 3/4-10 Lock Nut x2
  - 9/16-12 x 3.5 Hex Head Bolt x2
  - 9/16-12 Lock Nut x2
  - 9/16" Flat Washers x4
- 10130BAG4: *Front / Rear Brake Line Bracket Hardware*
  - 5/16-18 x 3/4 Hex Head Bolt x8
  - 5/16" Flat Washer x8
  - 5/16-18 Flange Lock Nut x8
  - 3/8-16 x 1-1/4 Hex Head Bolt x4
  - 3/8" Flat Washers x4
  - 3/8" Bump Stop Flag Nut x4
- 10130BAG5: *Brake Line Brackets*
  - Rear Axle Brake Line Brackets x5
  - Front Brake Line Brackets x2
  - Brake Line Bracket x2
  - Diff Brake Line Bracket x2
  - Front Skid Plate Brackets x2
  - Rr Bump Stop Flag Nuts x4
- 10130BAG8: *For Sway Bar Relocation*
  - 3/8" Lock Washer x4
  - 3/8-16 x 1-1/2 Hex Head Bolt x4
  - 3/8-16 Hex Nut x4
  - 5/16" Flat Washer x4
- 5/8BAG: *For U-Bolts*
  - 5/8-18 Nylock Nuts x8
  - 5/8" Flat Washers x8
- 1592BAG4: *For Anti-wrap Blocks*
  - 7/16 U-Bolts x4
  - 7/16" Flat Washers x8
  - 7/16-14 Top Lock Nuts x8

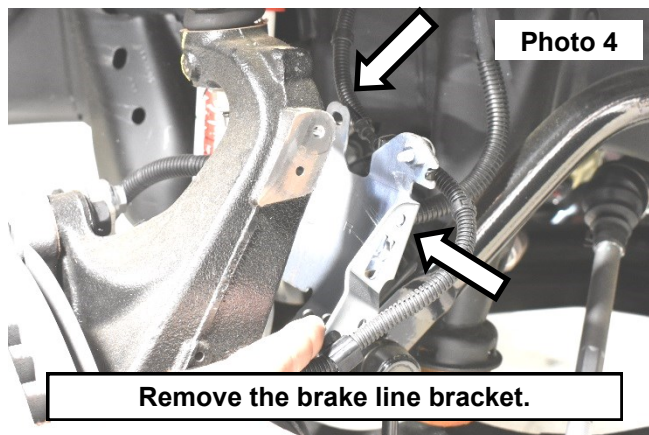
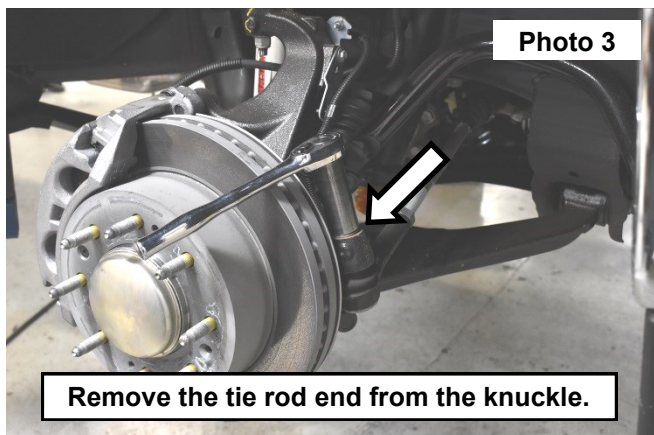


## INSTALLATION INSTRUCTONS

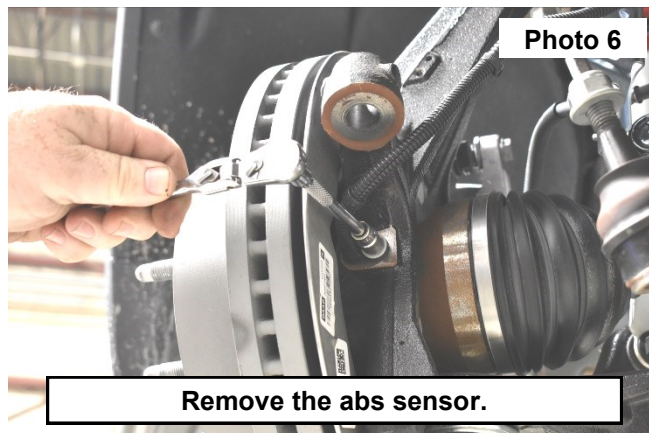
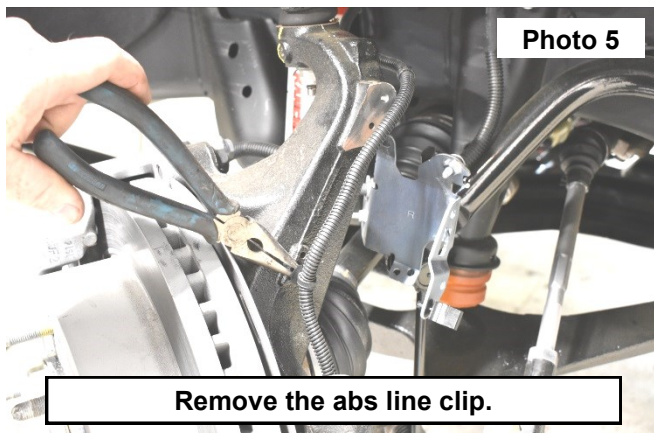
1. Chock the rear wheels.
2. Jack up the front of the vehicle.
3. Place jack stands on the frame behind the lower control arms.
4. Lower the vehicle onto the jack stands and remove the tires and wheels.
5. Place the floor jack under the differential.
6. Using a tape measure record the length from the threaded block to the end of the bolt head here \_\_\_\_\_. **See Photo 1.** This will be a starting length when the vehicle is complete.
7. Using a 21mm socket, remove the torsion bar adjusting bolt. Using a torsion bar tool, unload the torsion bars and remove the adjusting block. Retain the stock hardware **See Photo 2.**
8. Slide the torsion bar forward to remove the torsion bar key.



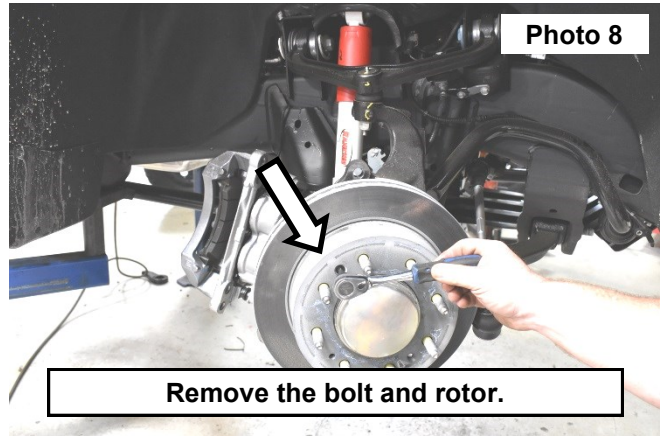
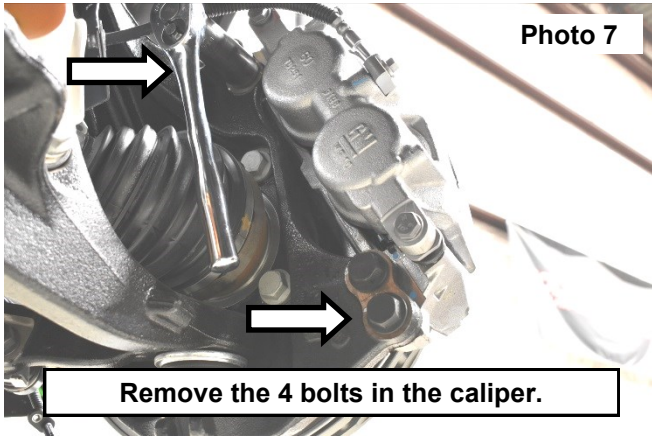
9. Loosen the tie rod end nut using a 21mm socket. Then strike the end of the tie rod end boss to unseat the taper using a hammer. **See Photo 3.**
10. Remove the nut and tie rod end from the knuckle. Retain hardware.
11. Using a 10mm wrench remove the 2 brake line bracket bolts on the front and back side of the knuckle. Retain hardware. **See Photo 4.**



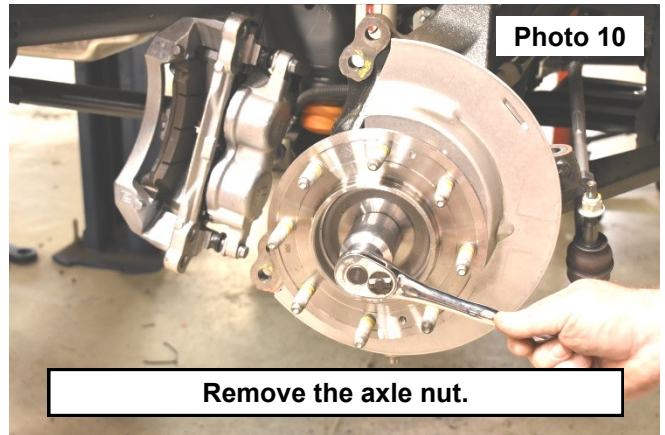
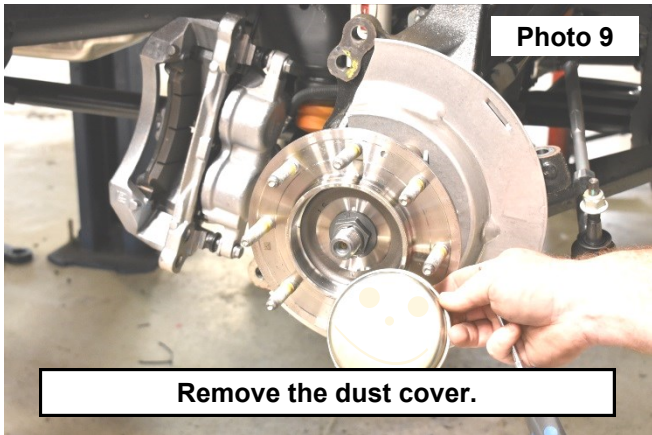
12. Remove the abs line from the knuckle. **See Photo 5.**
13. Remove the abs sensor from the knuckle using a 10mm socket. **See Photo 6.** Retain hardware.



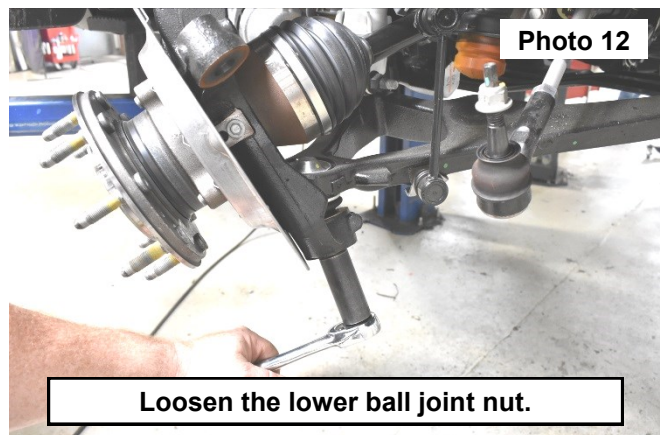
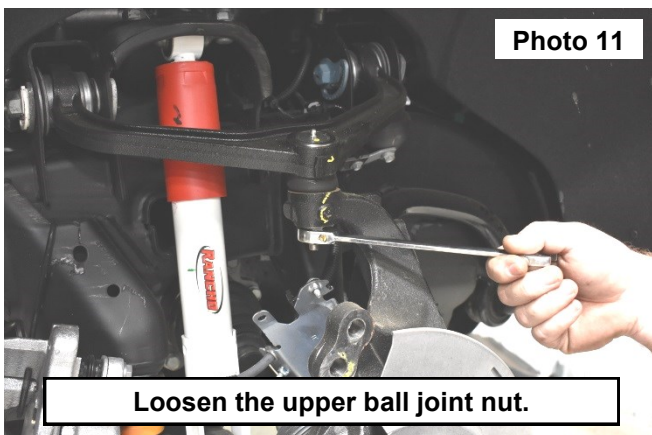
14. Remove the 4 brake caliper bolts using a 21mm socket and hang caliper out of harms way. **See Photo 7.** Retain hardware.
15. Remove the bolt in the brake rotor using a T30 torx bit. Set the rotor a side and retain the bolt. **See Photo 8.**



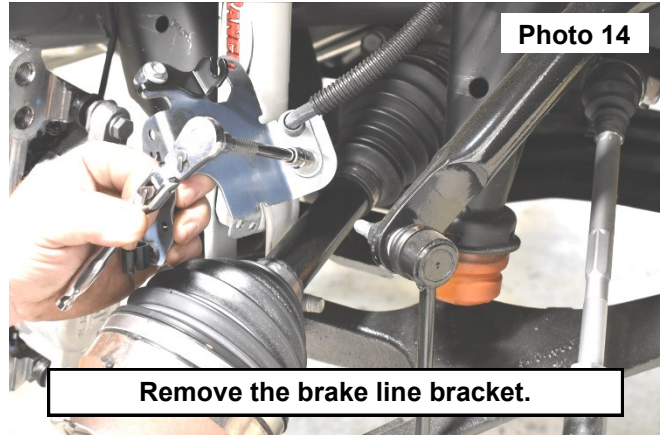
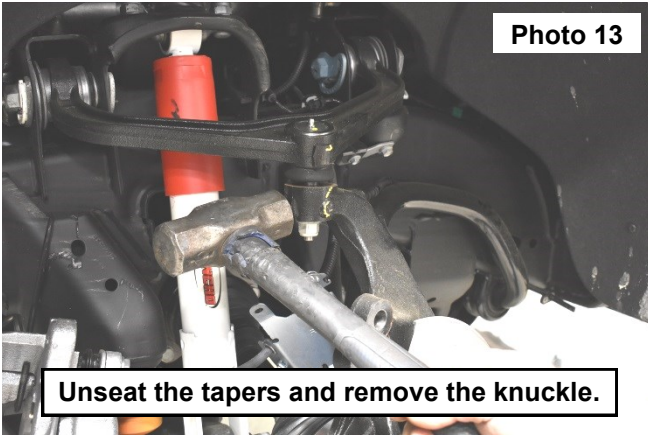
16. Using a small pry tool remove the dust cover from the hub. Retain for later use. **See Photo 9.**
17. Remove the axle nut using a 36mm socket. **See Photo 10.**



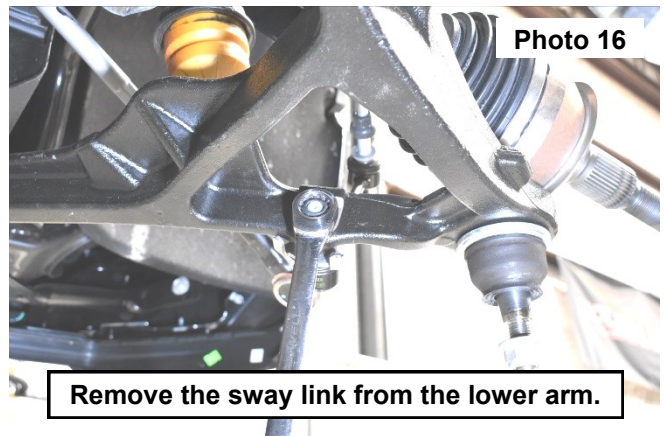
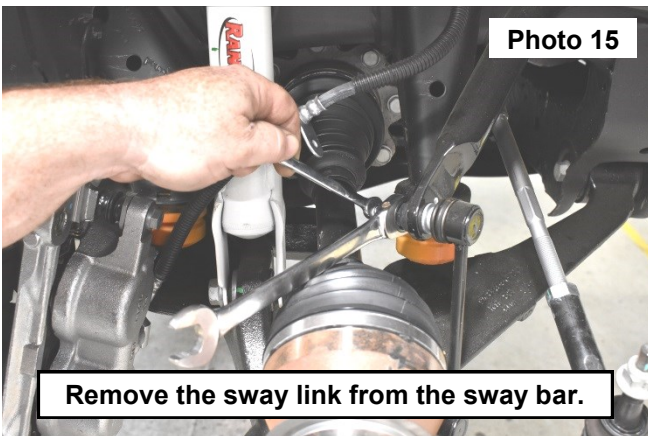
18. Loosen the upper ball joint nut using a 18mm socket. **See Photo 11.**
19. Loosen the lower ball joint using a 24mm socket. **See Photo 12.**



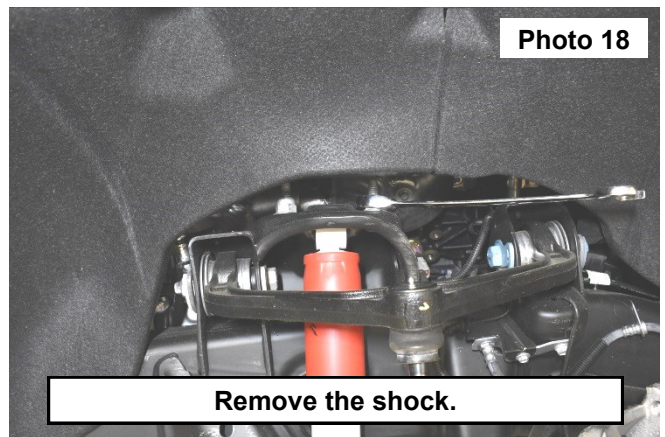
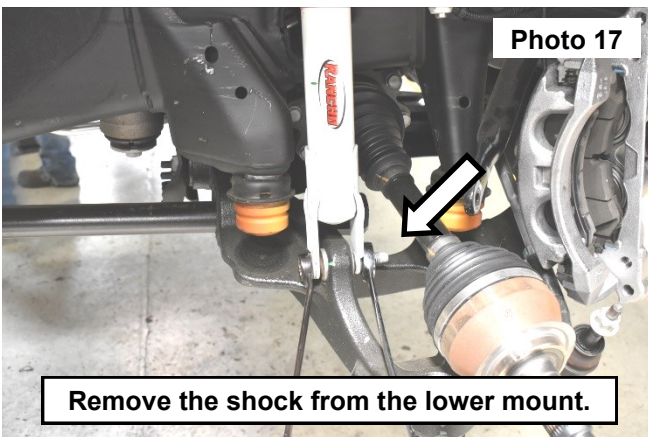
20. Use a hammer to unseat the taper on the upper and lower ball joints, then remove the nut from each ball joint and remove the knuckle. **See Photo 13.**
21. Remove the brake line bracket from the brake line using a 10mm socket. **See Photo 14.**



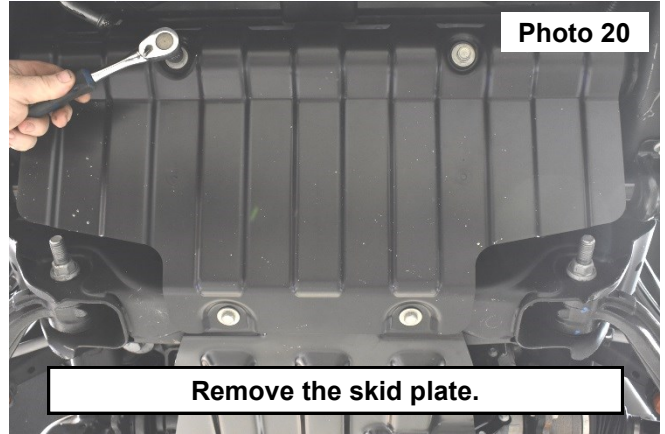
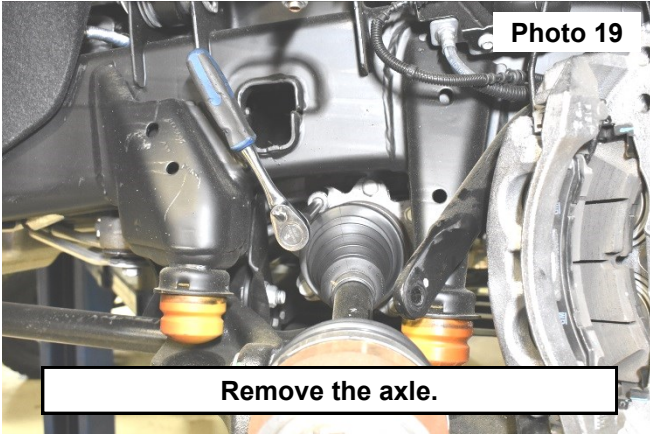
22. Remove the sway bar link from the sway bar and the lower control arm using a 9mm wrench on the upper stud and a 18mm wrench on the remaining nuts. **See Photos 15 and 16.**



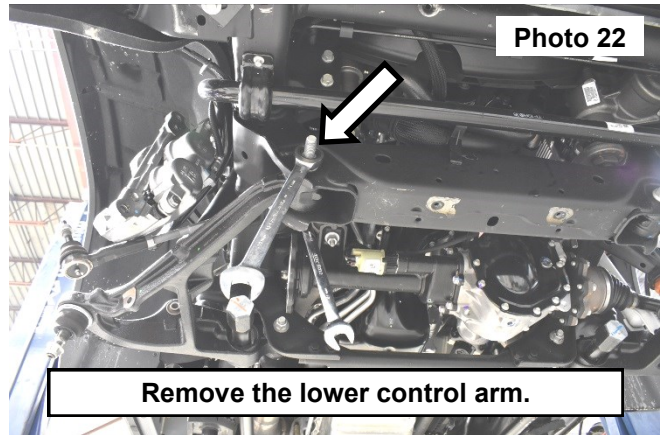
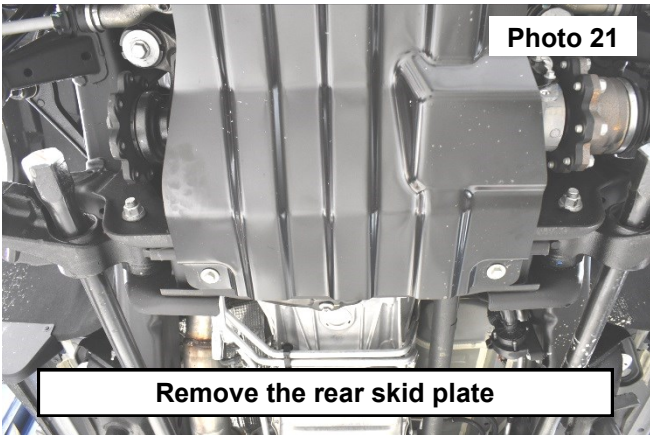
23. Support the lower control arm. Then remove the shock from the lower control arm mount using a 21m wrench. **See Photo 17.** Retain hardware.
24. Remove the nuts from the upper shock mount using a 21mm wrench. Then remove the shock. **See Photo 18.**



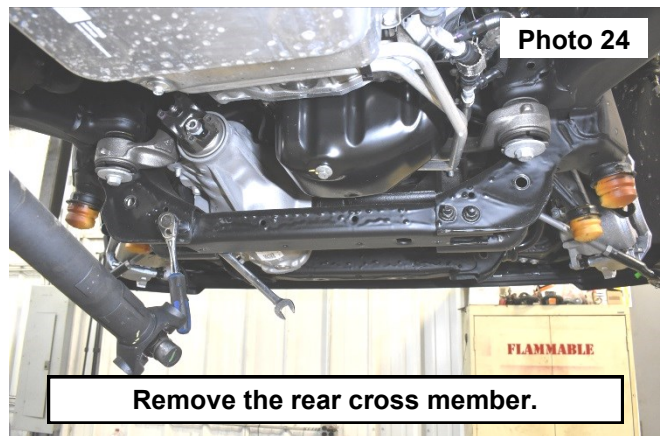
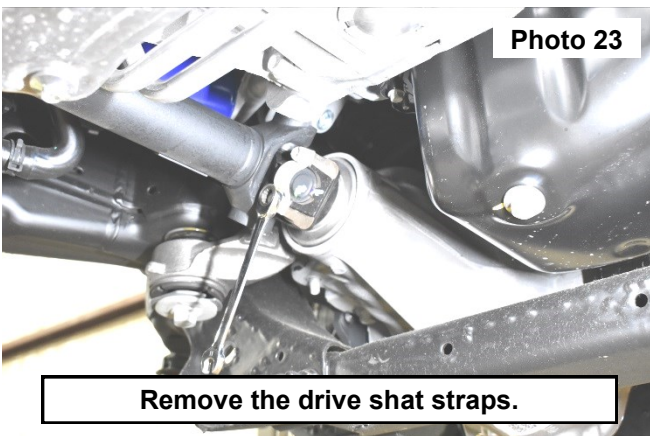
25. Remove the 8 bolts in the axle to the diff flange. Remove the axle and set aside in a safe place. **See Photo 19.**  
26. Remove the 4 bolts in the front lower skid plate using a 15mm socket. **See Photo 20.** Remove the skid plate from the vehicle.



27. Remove the 2 bolts from the rear lower skid plate using a 15mm socket. **See Photo 21.**  
28. Loosen the lower control arm bolts using a 21mm and a 24mm wrench.

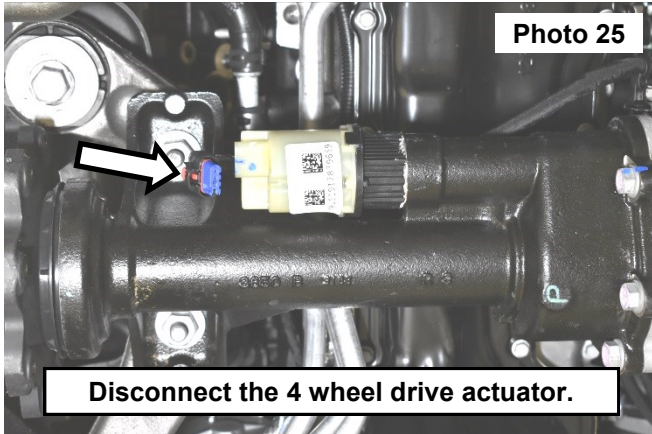


29. Remove the bolts and the lower control arm with the torsion bar, at the same time. **See Photo 22.** Retain hardware.  
30. Mark the driveshaft and remove the 4 bolts from the diff using a 11mm socket. Retain hardware. **See Photo 23.**

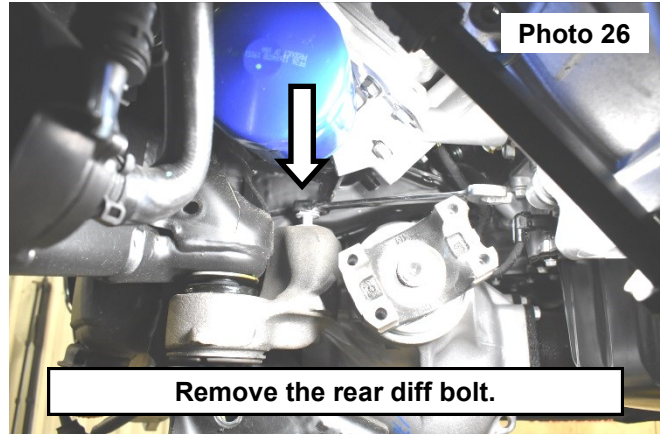




- 31. Using a 18mm socket remove stock rear cross-member. **See Photo 24.**
- 32. Unplug diff hose and 4 wheel drive actuator from the diff. **See Photo 25.**

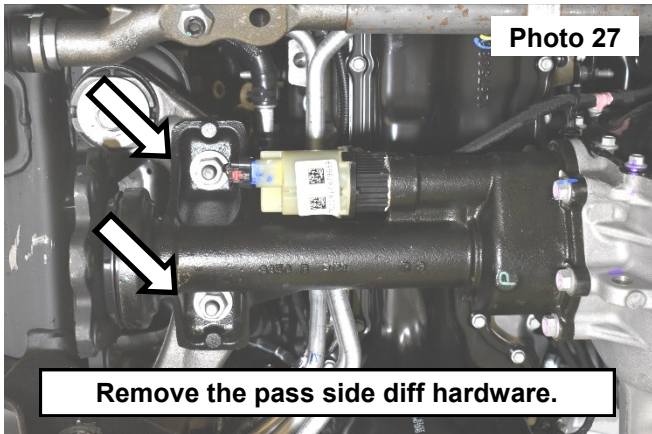


**Photo 25**  
Disconnect the 4 wheel drive actuator.

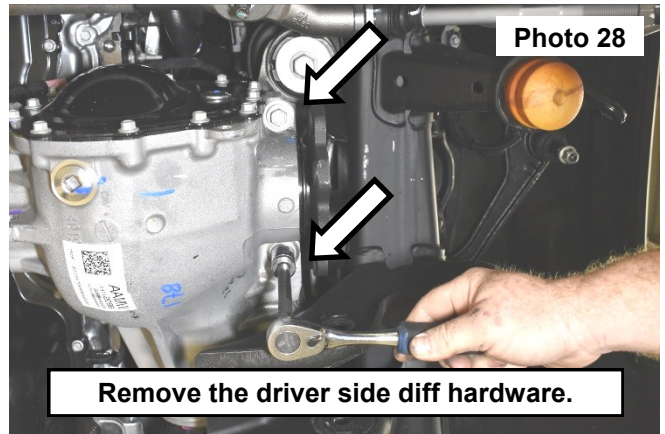


**Photo 26**  
Remove the rear diff bolt.

- 33. Using a 18mm socket remove the diff bolt on driver side diff mount. **See Photo 26.**
- 34. Support the diff. Then remove the nuts from the diff mount on the passenger side using a 21mm socket. **See Photo 27.** Retain hardware.
- 35. Remove the bolt from the front driver side bolt using a 15mm socket. Then remove the rear bolt using a 18mm socket. **See Photo 28.** Retain hardware.
- 36. Remove the diff from the vehicle. Set aside for reuse.

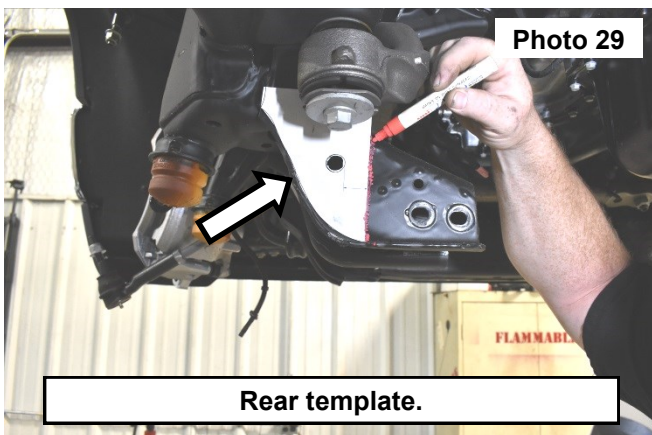


**Photo 27**  
Remove the pass side diff hardware.

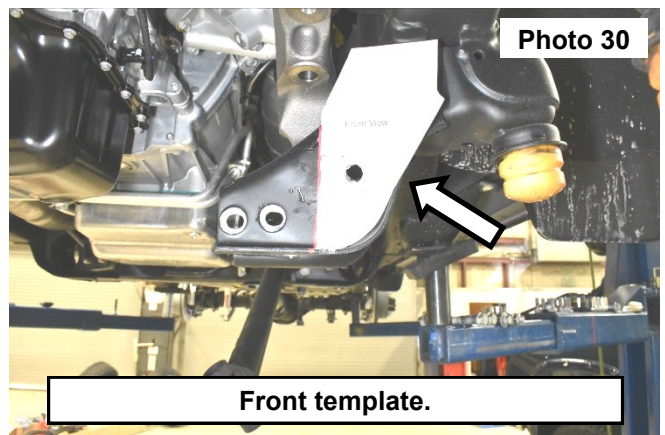


**Photo 28**  
Remove the driver side diff hardware.

- 37. Place the template onto the driver side rear control arm mount using tape or as shown with a pant pen.
- 38. Mark the template in the areas that will be trimmed using a scribe or a paint marker. **See Photos 29-31.**

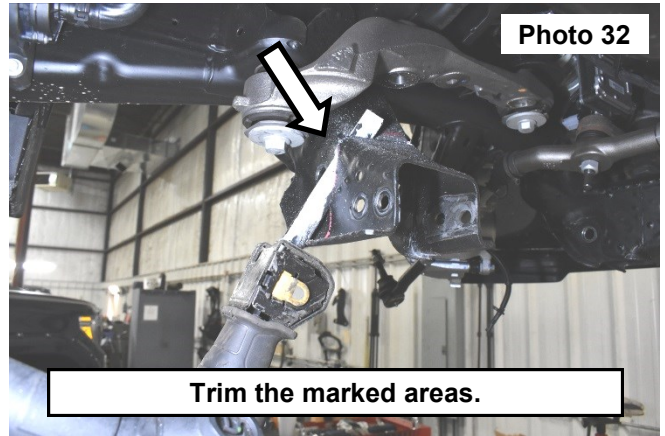
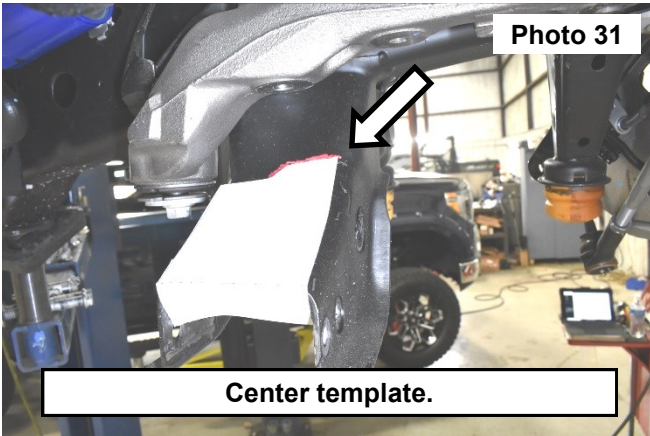


**Photo 29**  
Rear template.

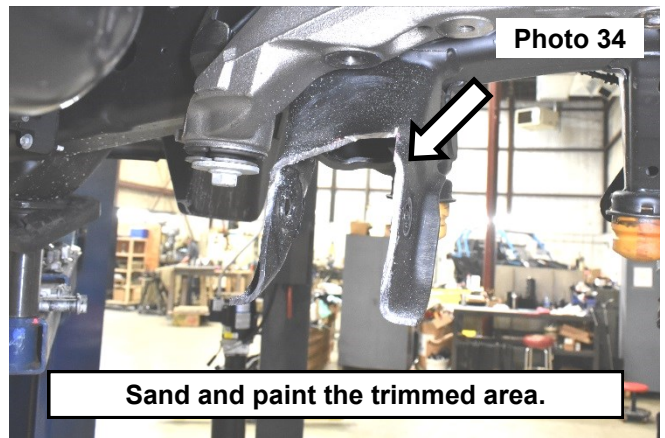
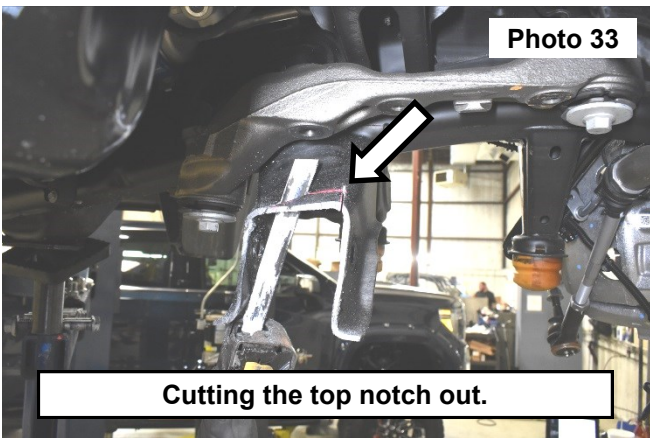


**Photo 30**  
Front template.

39. Cut through the front to the back of the mount to allow space from the differential using a reciprocating saw. See **Photos 32 and 33.**

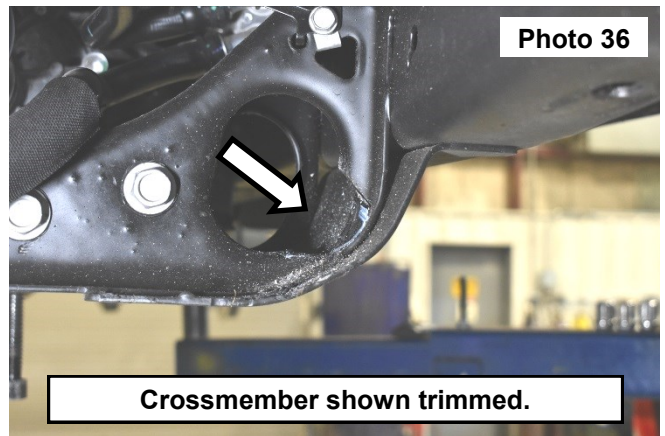
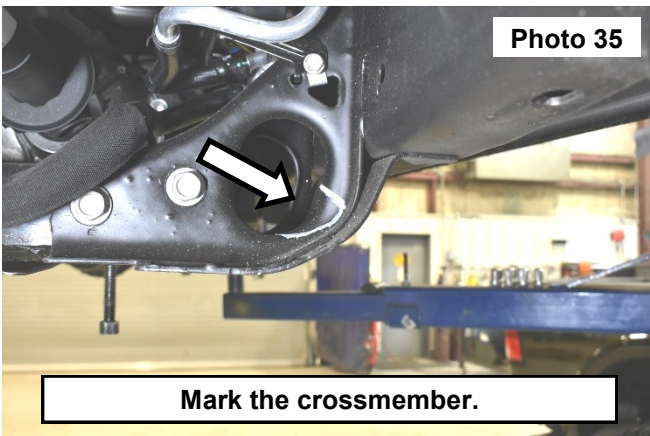


40. Sand and paint the trimmed area to prevent rust. See **Photo 34.**

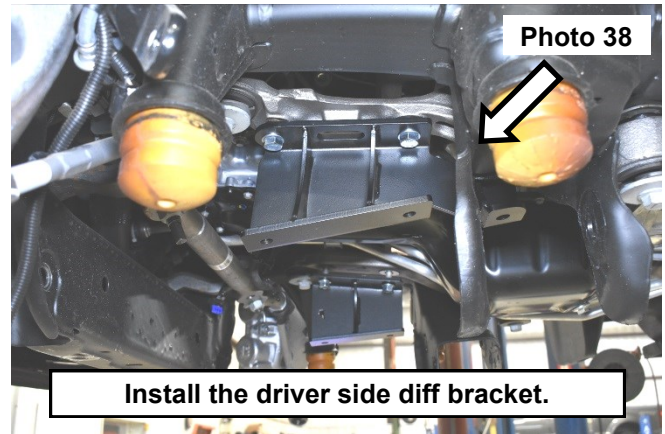
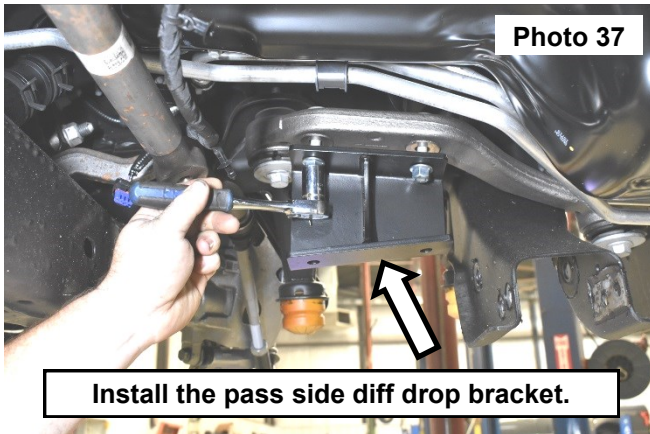


41. Mark the front of the transmission crossmember, on driver and pass sides, as shown in **Photo 35.**

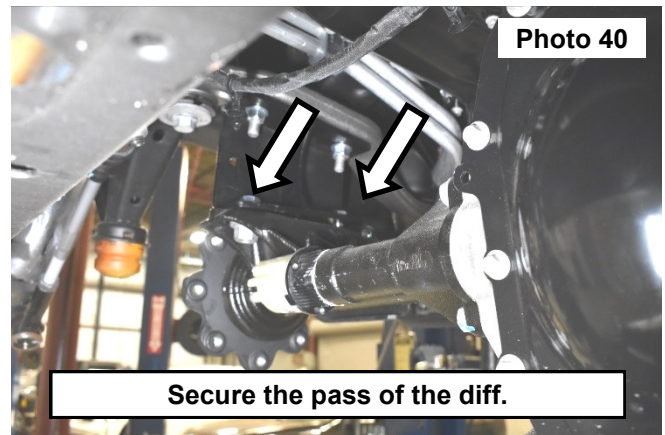
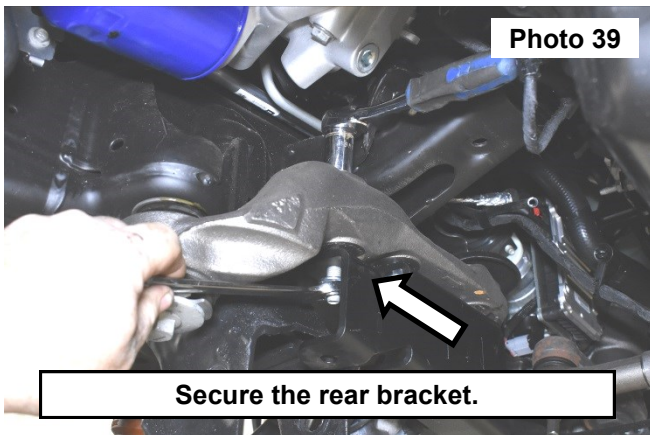
42. Trim the crossmember using reciprocating saw. Sand and paint the trimmed area to prevent rust. See **Photo 36.**



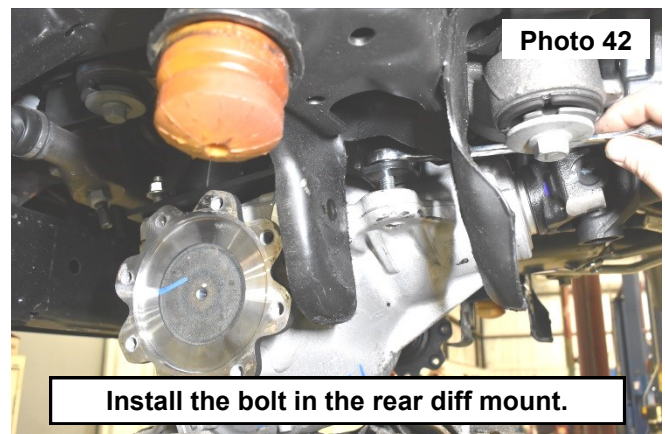
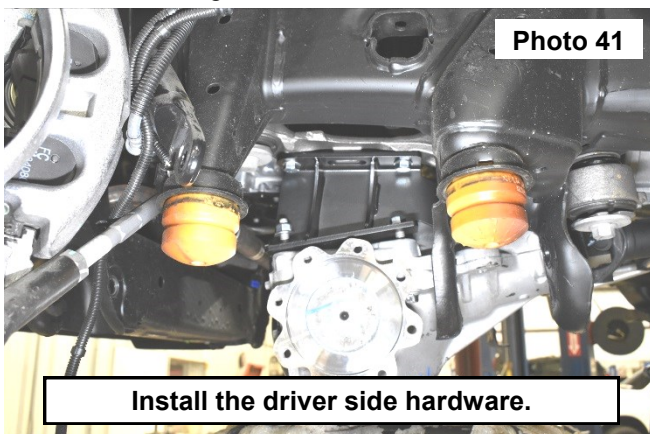
43. Install the passenger side diff bracket using (2) of the supplied 12mm-1.75 flange nut in 10130BAG1. Torque to 70 ft-lbs. using an 18mm socket. **See Photo 37.** "P" will face forward and upright when looking from outside of truck.
44. Install the driver side diff drop bracket. Apply thread locker to the (2) 12mm-1.75 x 35mm bolts and (2) of the supplied 12mm flat washers. Torque to 70 ft-lbs. using an 19mm socket. **See Photo 38.**



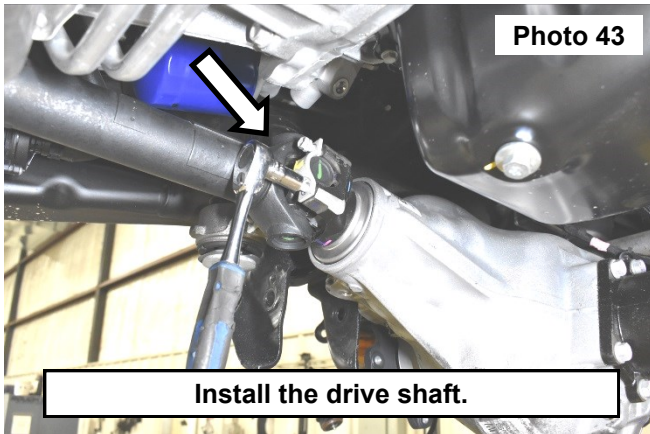
45. Secure the rear mount on the driver side bracket using the retained OE bolt and (1) of the supplied 12mm-1.75 flange nut. Tighten using an 18mm wrench and socket. **See Photo 39.**
46. Support and install the diff onto the installed drop brackets. Locate 10130BAG1 for diff installation hardware.
47. Secure the diff on the passenger side using (2) of the supplied 12mm flat washers and (2) 12mm-1.75 x 35mm bolts and the retained nuts with the attached large washer on the diff mount side. **See Photo 40.** Tighten using a 21mm socket on the OE nut and a 18mm wrench on the bolt.



48. Secure the diff on the driver side using the retained diff bolts in the front side of the diff. Secure using (2) 12mm-1.75 nuts. **See Photo 41.** Torque to 70 ft-lbs. using a 18mm wrench and a 15mm and 18mm socket.
49. Install (1) of the supplied 12mm flat washers and (1) 12mm-1.75 x 35mm bolts in the rear mount on the diff. Torque to 70 ft-lbs. using a 18mm wrench. **See Photo 42.**

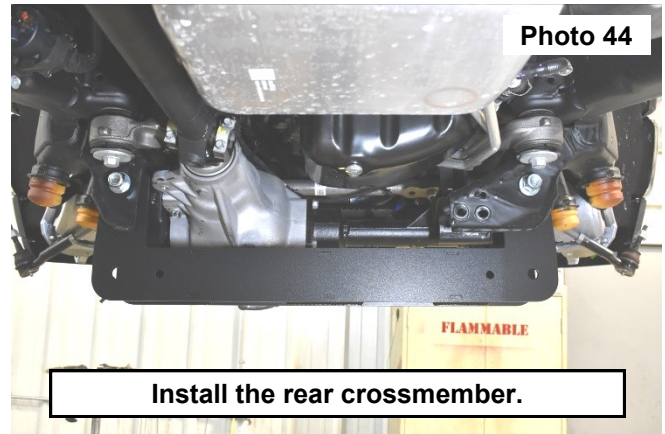


50. Install the front drive shaft into the diff and secure using the (2) retained OE straps and (4) bolts. **See Photo 43.** Torque to 19 ft-lbs. using a 11mm socket.
51. Reconnect vent tube and plug in the 4x4 actuator.
52. Locate 1253BAG2. Then install the rear crossmember, using (4) of the supplied .750 flat washers, (2) 18mm-2.5 x 140mm bolts and (2) 18mm-2.5mm nuts. **See Photo 44.** Do not tighten at this time



**Photo 43**

**Install the drive shaft.**



**Photo 44**

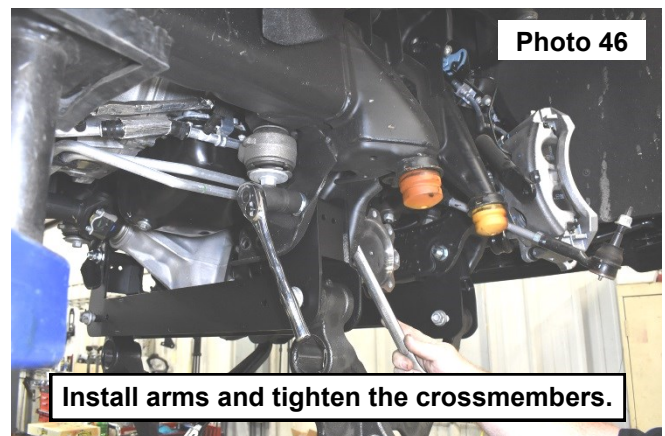
**Install the rear crossmember.**

53. Install the front crossmember, using (4) of the supplied .750 flat washers, (2) 18mm-2.5 x 120mm bolts and (2) 18mm-2.5mm nuts from 1253BAG2. **See Photo 45.** Do not tighten at this time.
54. Install the lower control arms into the crossmembers on each side of the vehicle using the retained OE hardware. Then torque the crossmembers to 189 ft-lbs. using 27mm wrench and socket. **See Photo 46.**



**Photo 45**

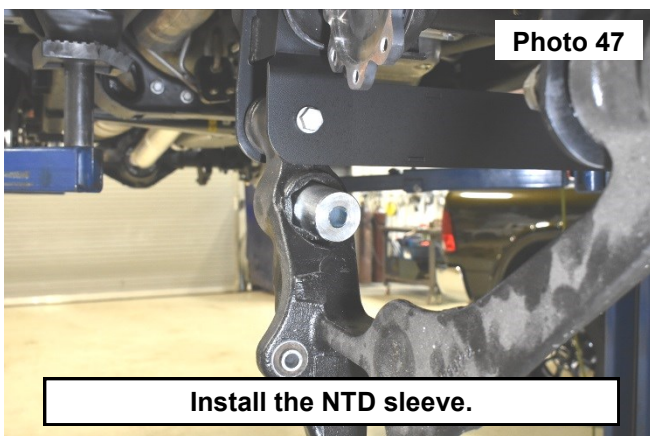
**Install the front cross member.**



**Photo 46**

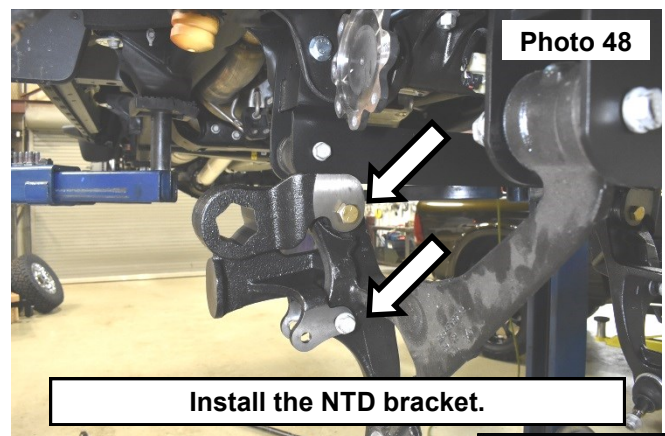
**Install arms and tighten the crossmembers.**

55. Install the supplied NTD sleeve in lower arm. **See Photo 47.**
56. Locate 10130BAG2. Then install the NTD onto the lower control arm. Secure the bracket and the installed sleeve using (2) 3/4 flat washers, (1) 3/4-10 x 6.0 hex head bolt and 3/4-10 nylock nut. Install the retained OE hardware through the bracket and rubber bushing mount on the control arm. Torque the 3/4 bolt to 267 ft-lbs. using a 1-1/8 socket. **See Photo 48.**



**Photo 47**

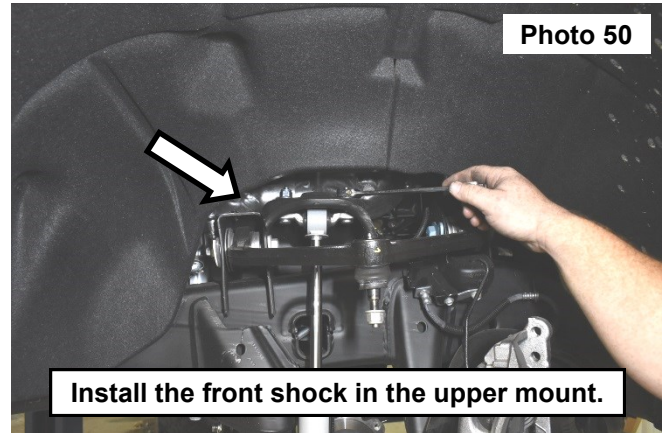
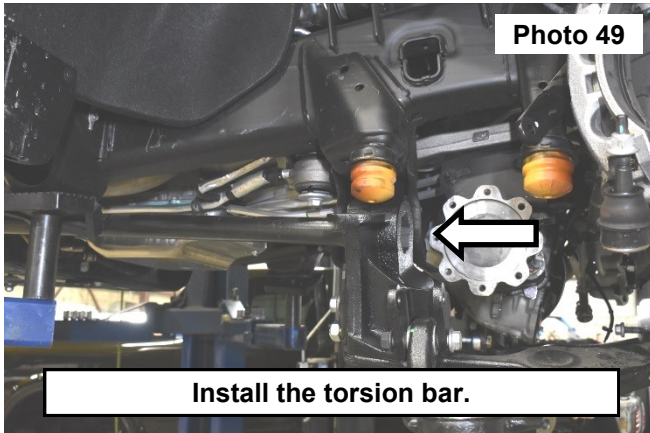
**Install the NTD sleeve.**



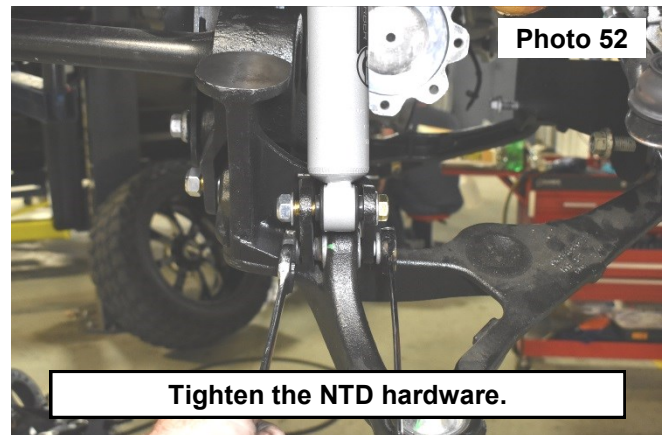
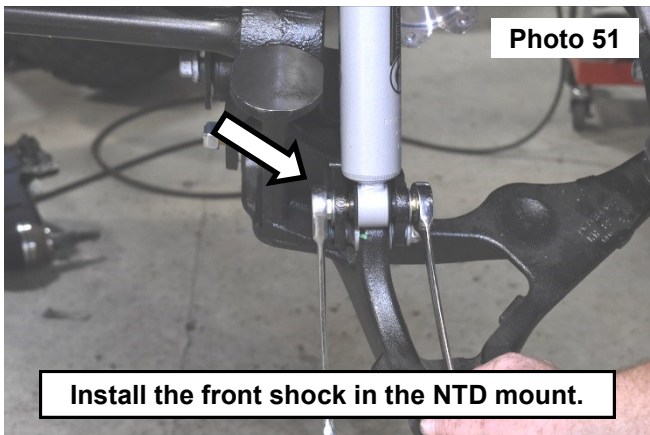
**Photo 48**

**Install the NTD bracket.**

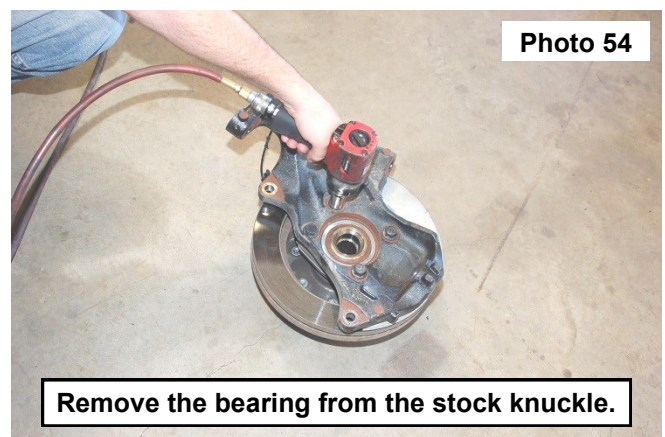
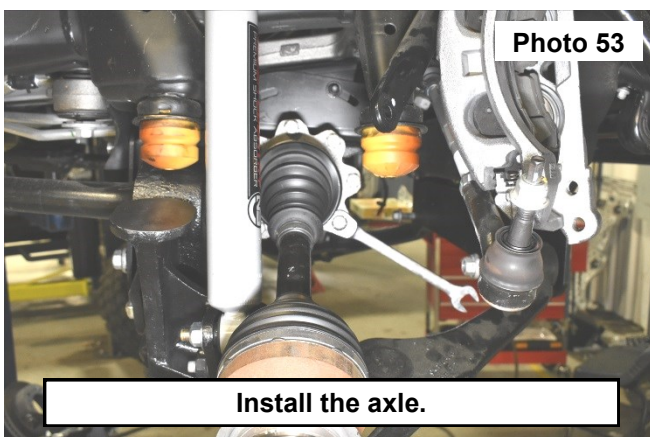
57. Support the lower control arm raising it up level. Then install the torsion bar through the NTD bracket and into the rear torsion bar crossmember. **See Photo 49.**
58. Install the front shocks part number (660776) into the bar pin mount on the frame using the supplied nuts. Torque to 55 ft-lbs. using an 18mm wrench. **See Photo 50.**



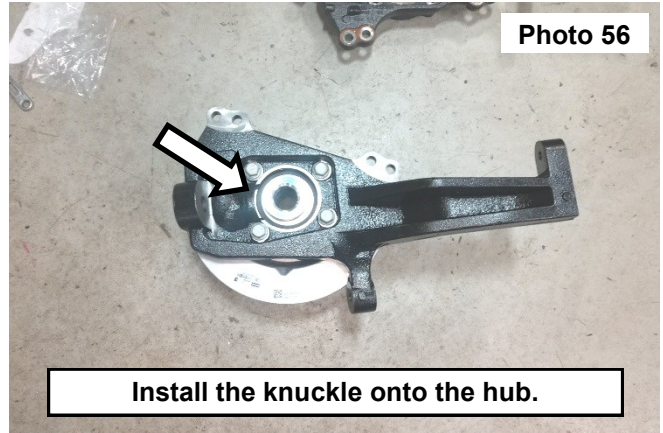
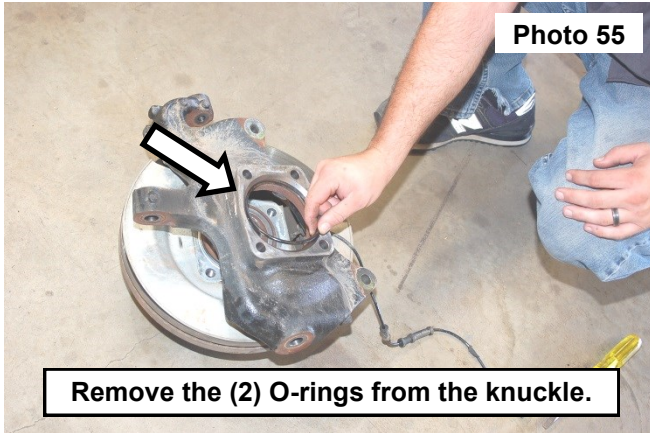
59. Install the shock into the NTD mount secure using (2) of the supplied 9/16 flat washers, (1) 9/16-12 x 3.5 hex head bolt and (1) 9/16 nylock nut. Torque to 120 ft-lbs. using a 21mm wrench and a 22mm socket. **See Photo 51.**
60. Torque to the 9/16 bolt in the NTD bracket to 120 ft-lbs. using a 21mm wrench and socket. **See Photo 52.**



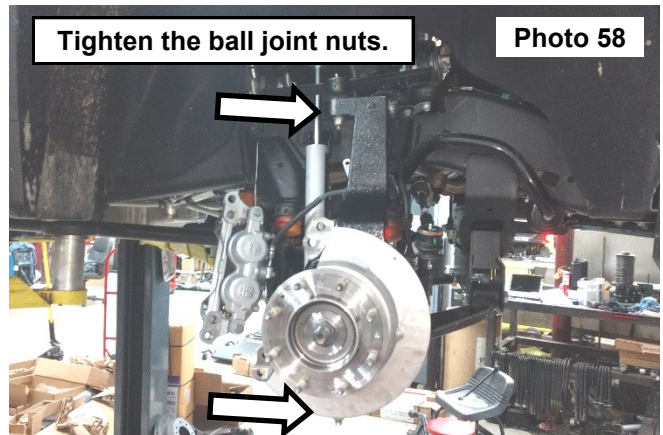
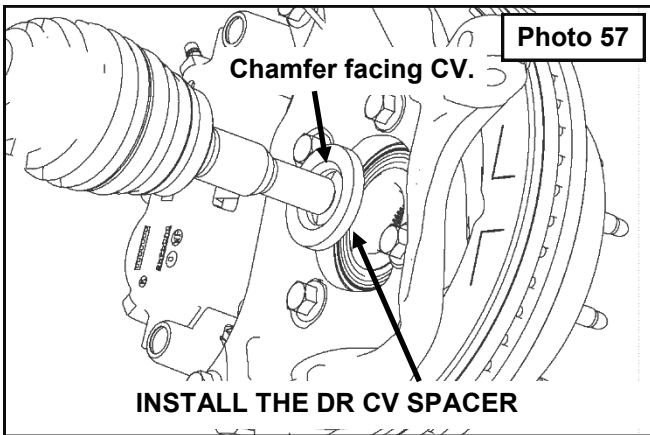
61. Install the axle onto the diff using the retained OE hardware. Torque to 45 ft-lbs. using a 18mm socket. **See Photo 53.**
62. Remove hub bearing from knuckle as shown in **Photo 54** using a 21mm socket.



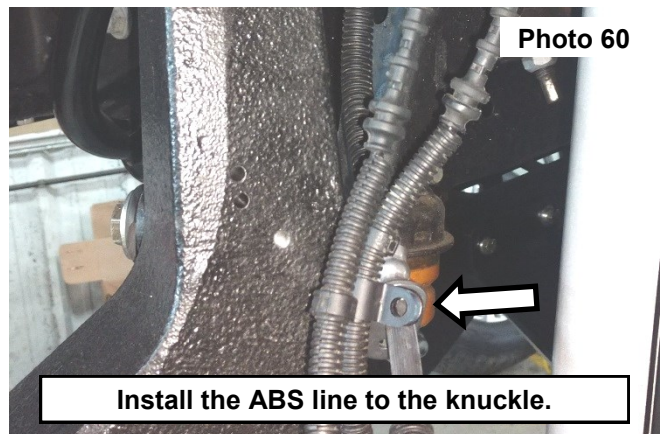
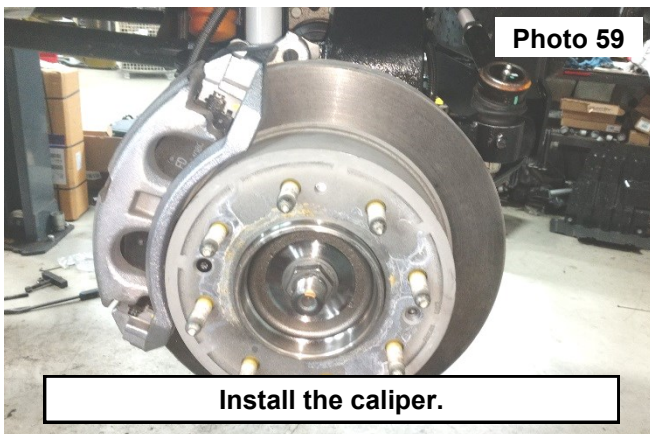
63. Remove the (2) O-rings and place inside the new knuckle. **See Photo 55.**  
 64. Install the new knuckle onto the hub and dust shield secure using the OE hardware. **Do not damage O-rings!**  
**NOTE:** Thread locker can be applied to the bolts. Torque to 126 ft-lbs. using a 21mm socket. **See Photo 56.**



65. Install the axle into the hub. Then install the knuckle onto the lower and upper ball joint using the retained OE hardware. **(Dr side only on the 7" kit– install the supplied CV axle spacer between the knuckle bearing and the CV shaft).** **See Photo 57.** Tighten the upper ball joint using a 18mm wrench on the upper ball joint.  
 66. Tighten the upper ball joint using a 18mm wrench and the lower ball joint using a 24mm socket. **See Photo 58.**  
 67. Install the axle nut onto the axle. Torque to 165 ft-lbs using a 36mm socket. Then install the dust cover onto the hub.

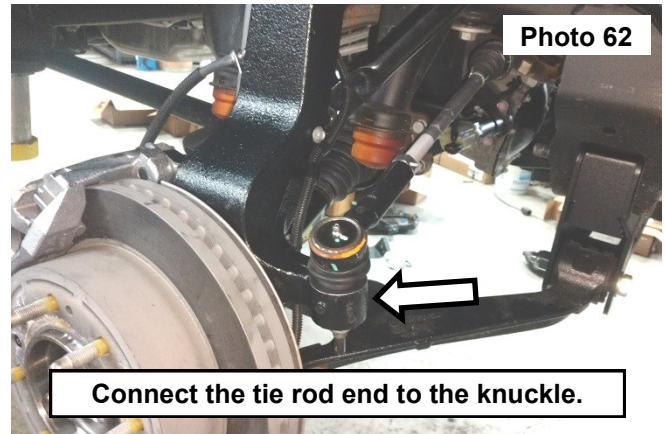
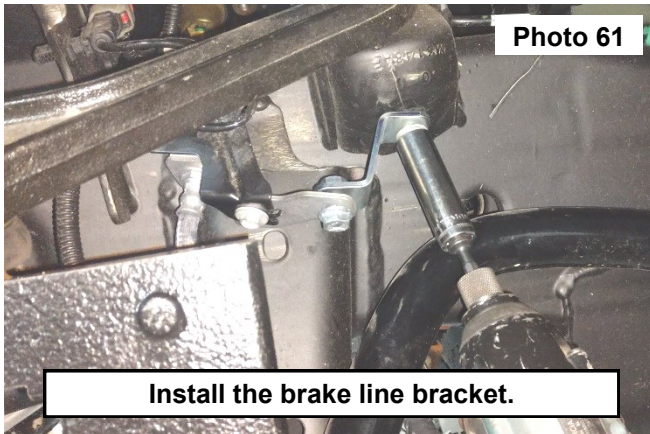


68. Install the rotor and secure using the retained bolt. Tighten using a T30 torx bit.  
 69. Install the brake caliper using the (4) retained bolts. Torque to 130 ft-lbs. using a 21mm socket. **See Photo 59.**  
 70. Install the ABS sensor into the knuckle using the retained hardware. Then install the ABS line to the front of the knuckle using the supplied retainer and the OE bolt. Tighten using a 10mm socket. **See Photo 60.**

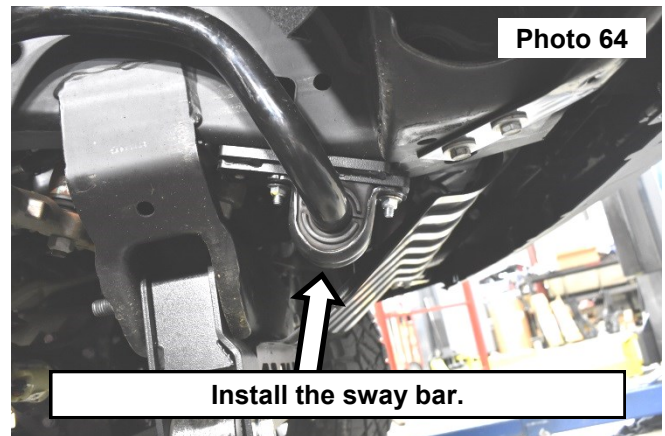
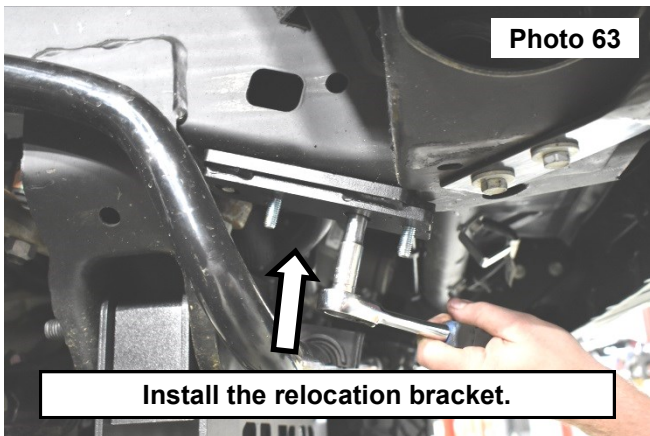


71. Remove the brake line bolt from the frame using a 13mm socket. Then install the brake line onto the frame using the retained bolt. Secure the brake line to the bracket using (1) 5/16 flat washers (1) of the supplied 5/16-18 x 3/4 hex head bolt and (1) 5/16-18 flange nut (10130BAG4). Torque to 15 ft-lbs. using a 13mm wrench and socket. **See Photo 61.**

72. Connect the tie rod end to the knuckle. Tighten using a 21mm socket. **See Photo 62.**



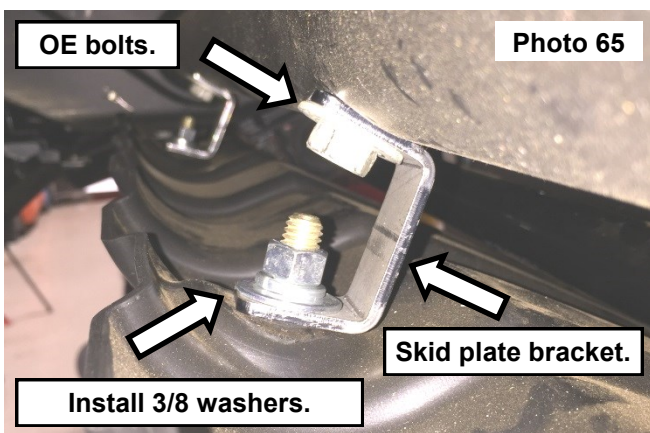
73. Remove the sway bar from the frame mount using a 10mm socket and retain the bolts. Install the (2) 3/8-16 x 1.25 hex head bolts into the sway bar relocation bracket. Install the brackets onto each side of the frame using the retained OE hardware. Torque to 30 ft-lbs. using a 10mm socket. **See Photo 63.**



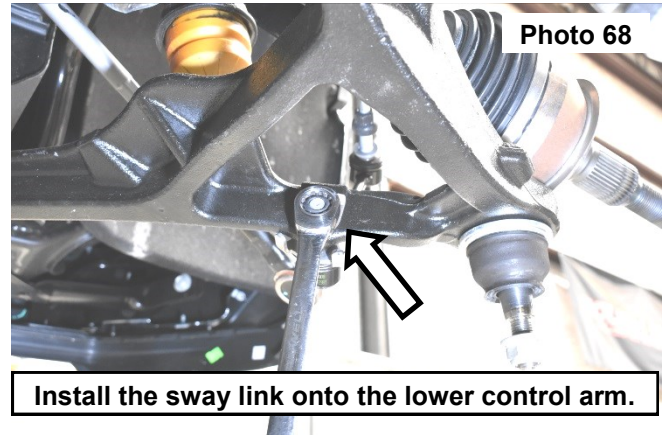
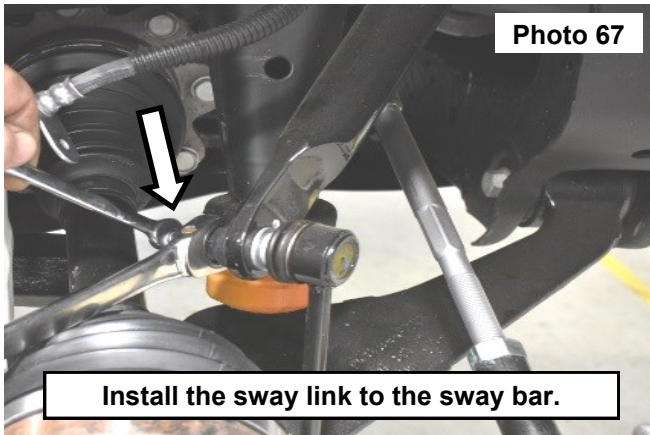
74. Install the sway bar onto the relocation bracket, secure using (2) of the supplied 3/8" flat washers and (2) 3/8-16 hex nuts on each side from bag 10130BAG8. Torque to 30 ft-lbs. using a 9/16 socket. **See Photo 64.**

75. Install the 2 skid plate brackets from 10130BOX4 onto the upper mount using the retained hardware. **See Photo 65.**

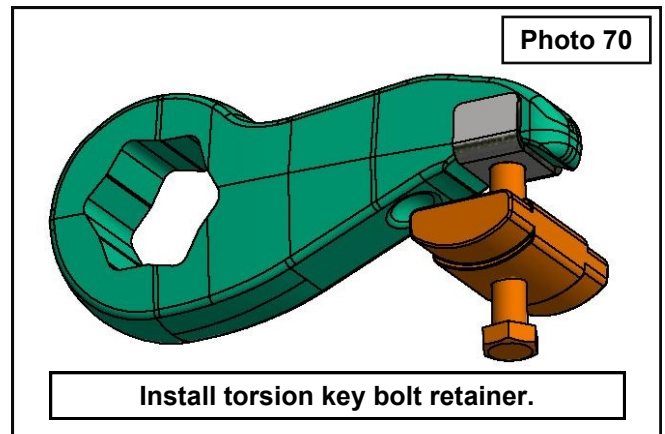
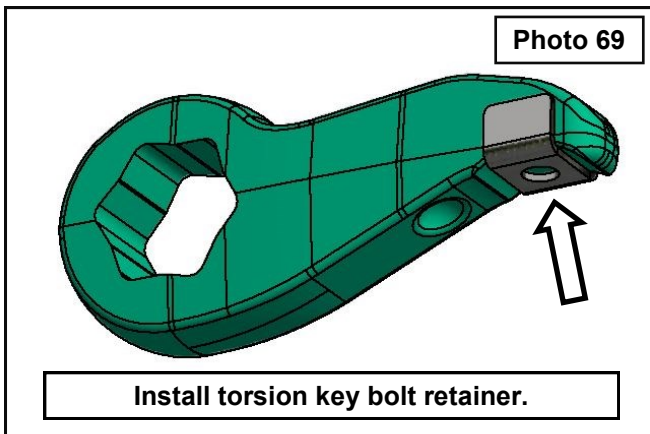
76. Install the skid plate using (2) of the supplied 3/8-16 x 1-1/4 hex head bolts, (2) 3/8" Large USS washers, (1) 3/8 lock washer and (1) 3/8-16 nut on each side from 10130BAG1. Tighten the OE bolts using a 15mm wrench and the 3/8" bolts using a 9/16 wrench and socket. **See Photos 65 and 66.**



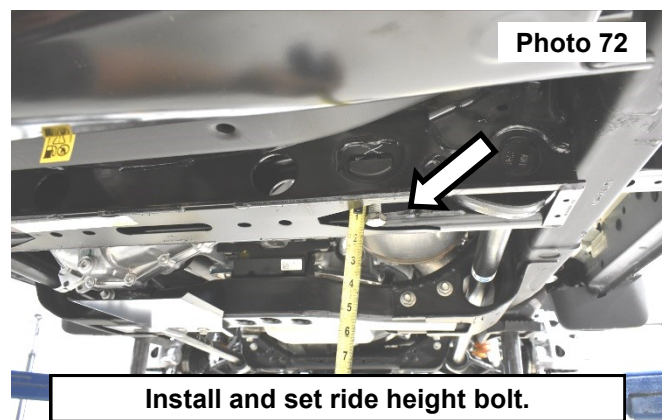
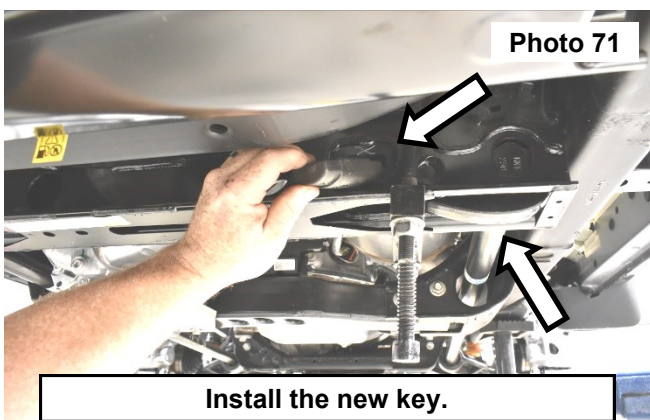
77. Install the Front Diff Skid Plate from 1253BOX6 and use hardware from 10130BAG1. Torque the bolts to 35ft-lbs. using a 9/16 wrench and socket.
78. Install the supplied sway link, and secure using the supplied 12mm nut. Tighten using a 18mm wrench and a 9mm wrench. **See Photo 67.**
79. Install the supplied sway link onto the lower control arm. Then secure using the supplied 18mm nut. Tighten using a 18mm wrench and a 9mm wrench. **See Photo 68.**



80. Install the supplied torsion key bolt retainer on the torsion key from 1959BAG9. **See Photos 69 and 70.**



81. Install the supplied key and bolt retainer, use the torsion bar tool to give clearance to install the threaded block. **See Photo 71.**
82. Install the bolt into the threaded block and set the starting ride height to the recorded measurement in step 6 using a 21mm socket. **See Photo 72.**

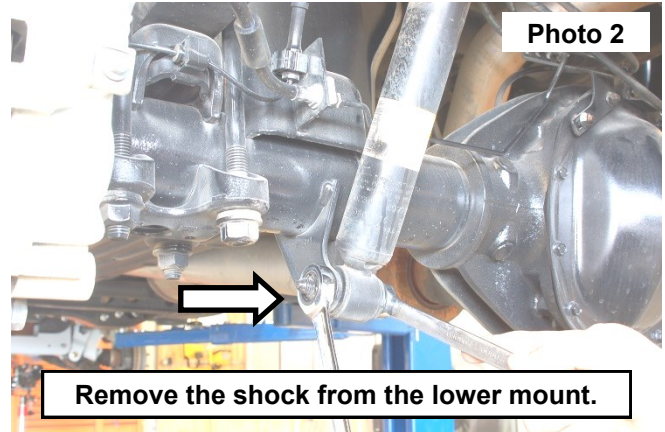
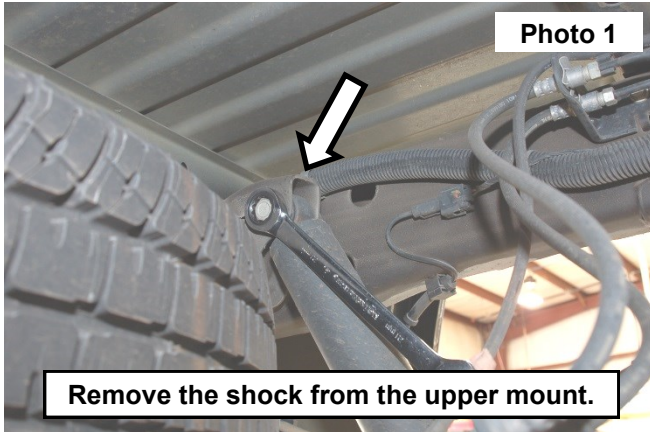


83. Install the wheels and tires.
84. Using a jack raise up the front of the vehicle then remove the jack stands and set on the ground.
85. This vehicle will need an alignment performed.
86. Check the front ride height, if adjustments needed use the jack to raise the vehicle and support with a jack stand before the bolt is adjusted.

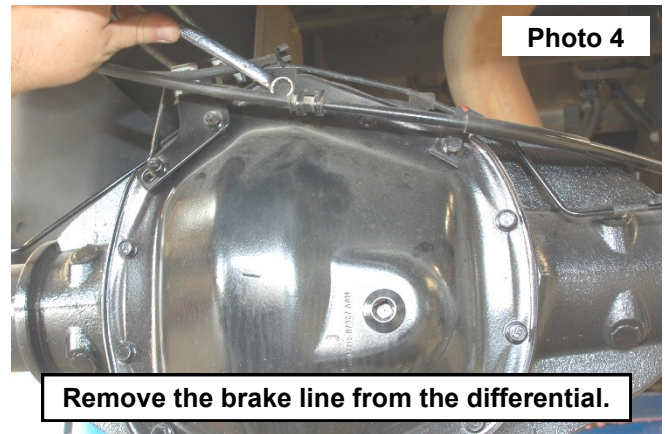
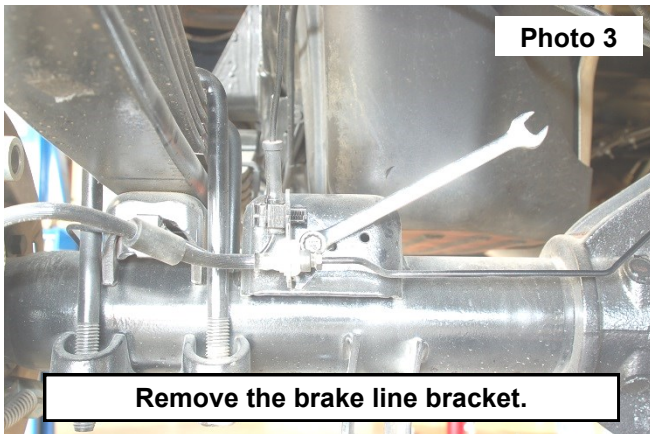


## REAR INSTALLATION INSTRUCTIONS

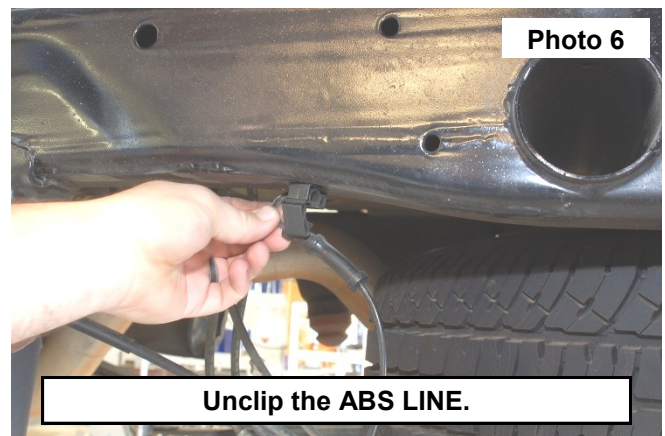
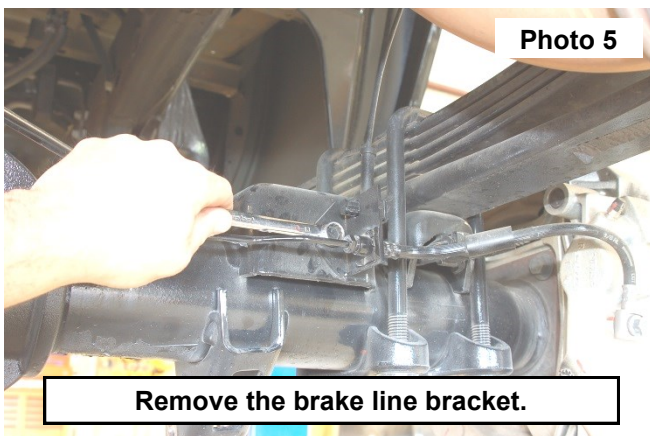
1. Chock the front tires.
2. Position a floor jack under the rear differential and jack up the vehicle.
3. Place jack stands under the frame rails just forward of the front leaf spring hangers and lower the frame on the jack stands.
4. Reposition the floor jack under the center of the differential and apply slight pressure for support, but do not raise the frame off the jack stands.
5. Remove the rear shock with a 21mm wrench on the upper and lower mount **See Photo 1 & 2.**



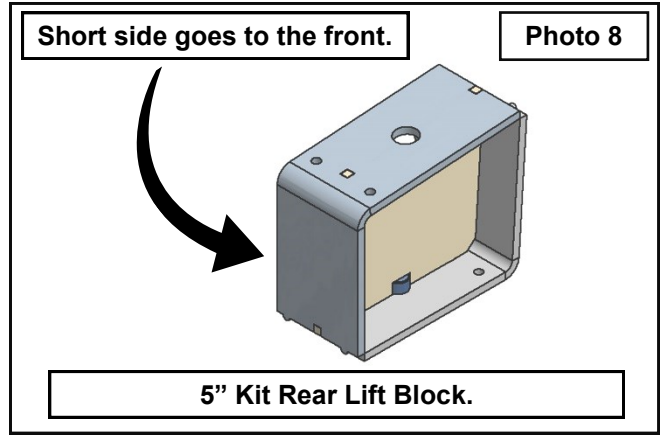
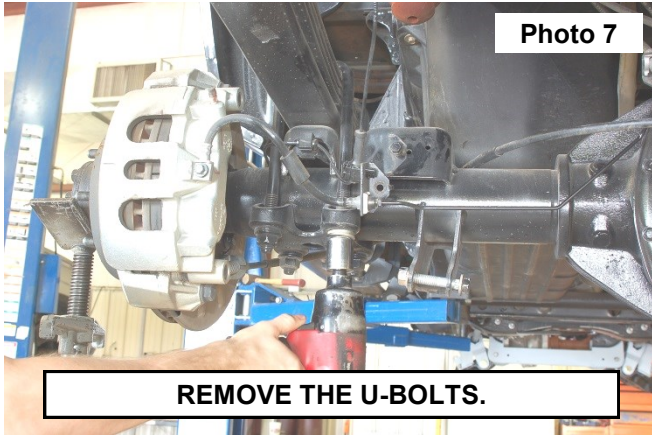
6. Remove the rear brake line and ABS mounts from the axle as shown using a 13mm socket/ wrench.
7. from the mount using a 13mm socket / wrench. brackets and e brake brackets off the rear end use 13mm wrench.
8. Remove the e-brake brackets from the drivers side, passengers side and center differential using a 13mm wrench. **See Photo 3, 4 & 5.** Retain the stock hardware for reuse.



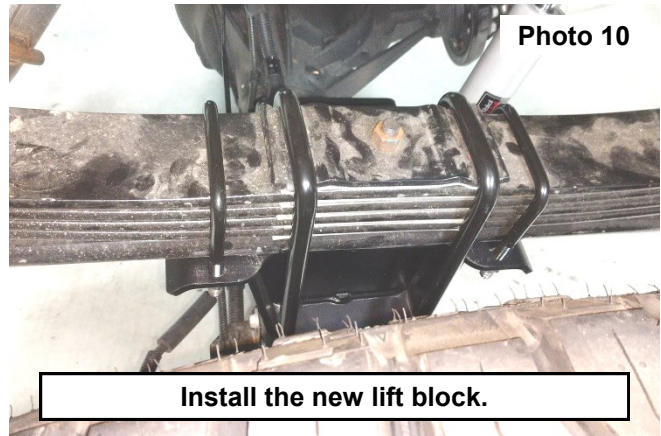
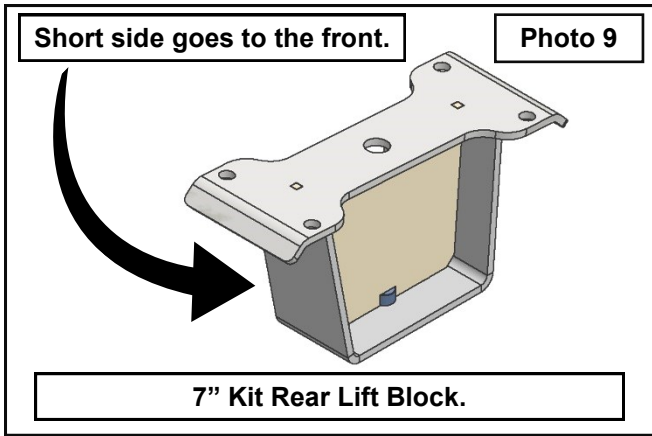
9. Release the line from the frame mount. **See Photo 6.**



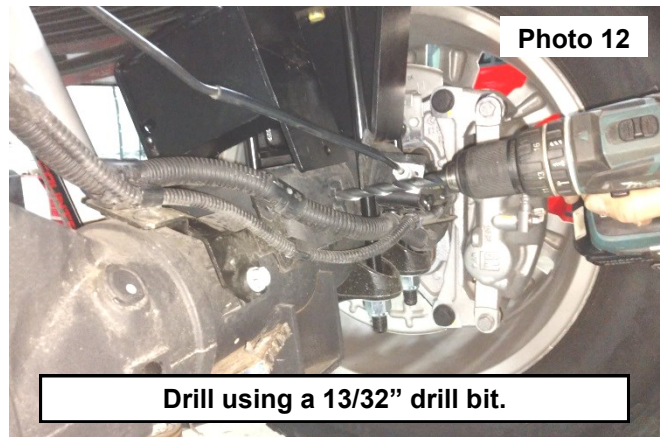
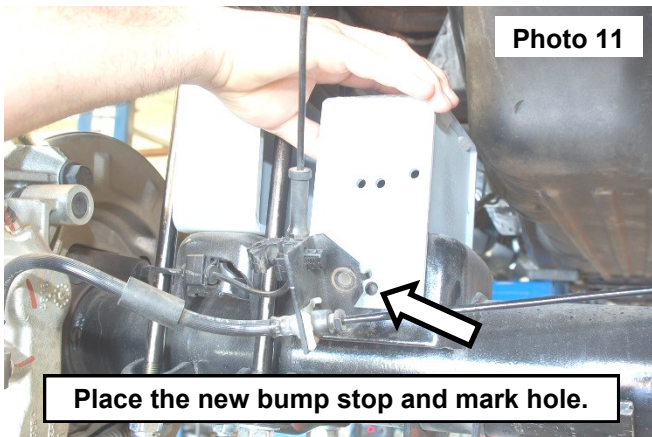
10. Remove U-bolts use 27mm socket and lower the axle with the floor jack enough to install the lift block. **See Photo 7.**
11. **NOTE:** Identify the blocks that will be installed with the 5" or the 7" kit.
12. **Photo 8** shows the block that will be installed for the 5" lift kit.



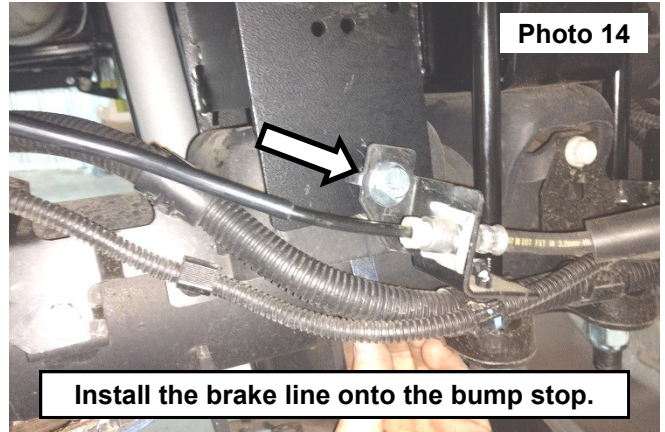
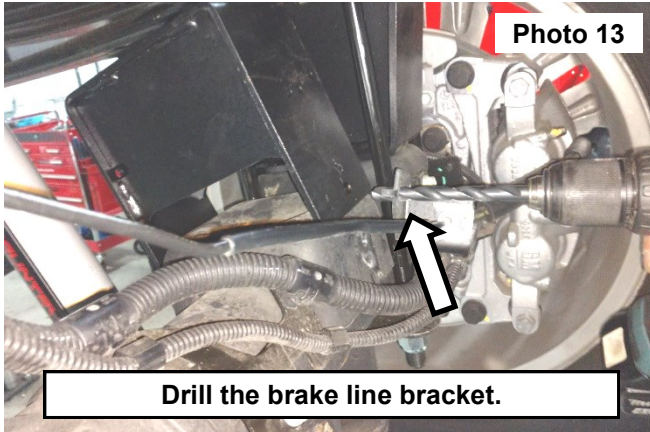
13. **Photo 9** shows the block that will be installed for the 7" lift kit.
14. Position the lift block on the leaf spring and axle. **See Photo 10.** If installing the 7" Kit Lift block install 1592BAG4 onto the anti-wrap portion of the block, torque to 45ft-lbs using a 5/8" socket.
15. Install the supplied u-bolts. Torque to 120ft-lbs using a 15/16" socket.



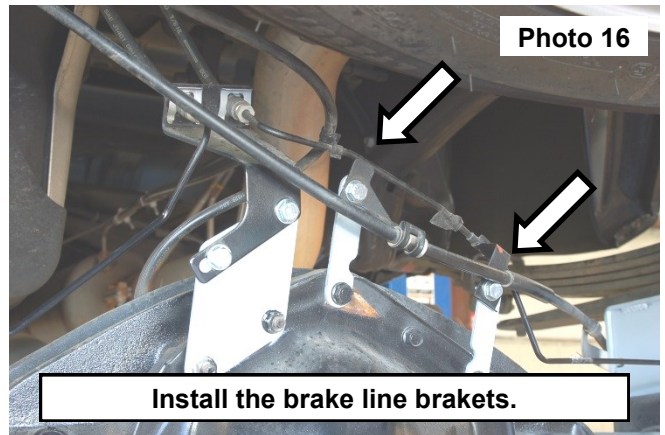
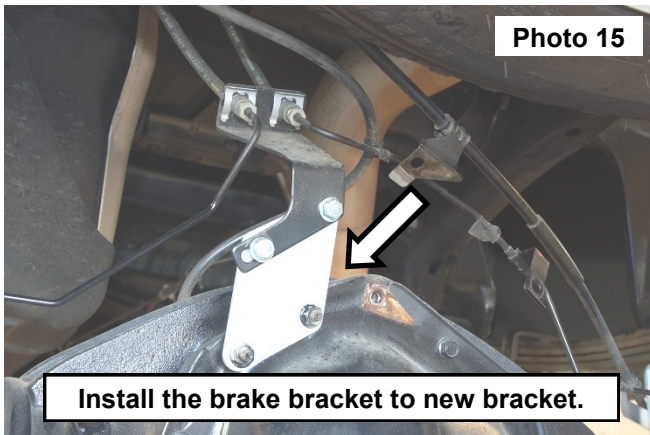
16. Install new bump stop on the axle. Center the bump stop on the mount and mark holes (front and rear of factory bump stop pad) to be drilled. **See Photo 11.**
17. Drill using a 13/32" bit. **See Photo 12.**



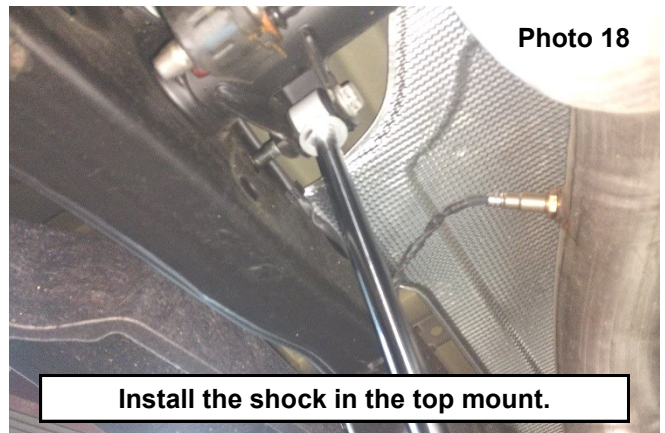
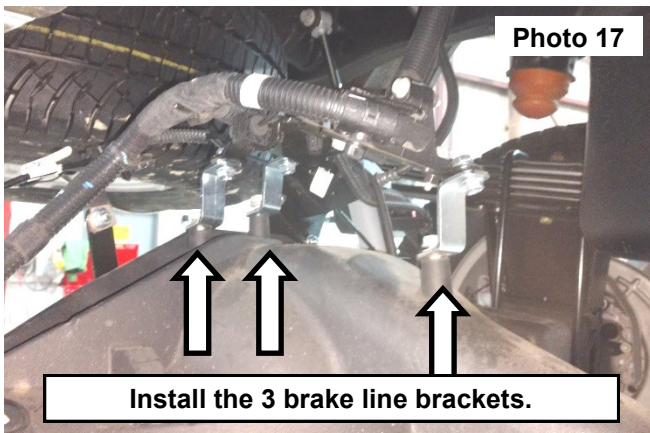
18. Using a 13/32" drill, drill out the brake line bracket mounting holes and flatten the tab using a pair of pliers. **See Photo 13.**
19. Install the supplied 3/8-16 x 1-1/4"bolts, 3/8" flat washers and flagnuts from 10130BAG4. On the rear mounting, the bolt will go through the brake line bracket, the supplied bump stop, and the factory bump stop pad. **See Photo 14.** Torque to 15 ft-lbs using a 13mm socket / wrench.



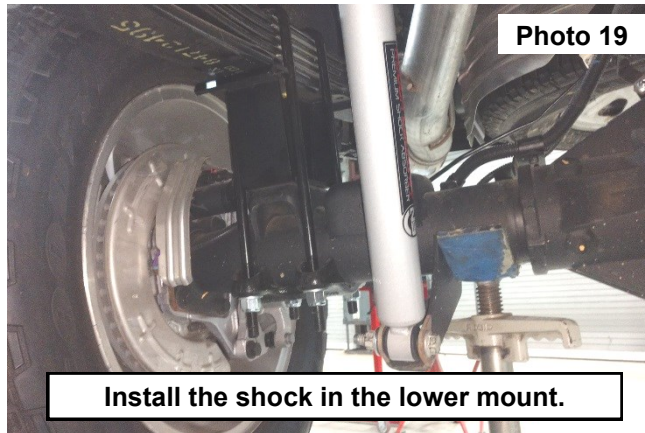
20. Reinstall the brake line bracket on the supplied bracket with the supplied 5/16" x 3/4" bolt, flat washers and lock nuts from 10130BAG4. **See Photo 15.** Torque to 15 ft-lbs. using a 1/2" socket / wrench.
17. Install the supplied brackets on the differential with the stock hardware. **See Photo 16.** Torque to 18 ft-lbs. using a 13mm socket / wrench. Reinstall the stock brake line brackets on the new brackets using the supplied 5/16" x 3/4"



- bolts, flat washers and lock nuts from 10130BAG4. Torque to 15 ft-lbs. using a 1/2" socket / wrench.
18. Remove the 3 bolts securing the brake line mount to the top of the rear diff. Retain hardware. Raise the bracket up and install the 3 retained bolts into the 3 brackets and into the diff. secure the brake line mount onto the brackets using the 3/8 hardware from 10130BAG4



19. Install the new rear shocks part number (660744) on the top and bottom mount using the retained hardware. **See Photos 17 and 18.** Torque to 80 ft-lbs. using a 21mm socket.
20. Install the new rear shock in the lower mount using the retained hardware. **See Photos 19.** Torque to 80 ft-lbs. using a 21mm socket.
21. Install the wheels and tires.



22. Using a jack raise up the rear of the vehicle then remove the jack stands and set on the ground.

### **POST INSTALLATION INSTRUCTIONS**

1. Check all fasteners for proper torque. Check to ensure for adequate clearance between all rotating, mobile, fixed, and heated members. Verify clearance between exhaust and brake lines, fuel lines, fuel tank, floor boards and wiring harness. Check steering gear for clearance. Test and inspect brake system.
2. On some vehicles the front lower skirting will need to be trimmed if using certain wheel /tire combinations and with heavy offset wheels. Trim only as needed.
3. Activate four wheel drive system and check front hubs for engagement.
4. Have a qualified alignment center align the vehicle immediately. Realign to factory specifications. Have headlights adjusted to proper settings.
6. Perform head light check and adjustment to proper settings.
7. Check and retighten wheels at 50 miles and again at 500 miles.
8. Recheck lifted height and adjust torsion bar as necessary.
9. All kit components must be retightened at 500 miles and then every three thousand miles after installation. Periodically check all hardware for tightness.
10. Install "Warning to Driver" decal on sun visor.
11. Bleed the brake system and test braking before driving on road.

Note: Installation of larger tires will require speedometer recalibration.

**Thank you for choosing Rough Country for all of your suspension needs.**

By purchasing any item sold by Rough Country, LLC, the buyer expressly warrants that he/she is in compliance with all applicable, State, and Local laws and regulations regarding the purchase, ownership, and use of the item. It shall be the buyers responsibility to comply with all Federal, State and Local laws governing the sales of any items listed, illustrated or sold. The buyer expressly agrees to indemnify and hold harmless Rough Country, LLC for all claims resulting directly or indirectly from the purchase, ownership, or use of the items.





